

Dell 34 Plus USB-C Monitor

S3425DW

User's Guide

Notes, cautions, and warnings

 **NOTE:** A NOTE indicates important information that helps you make better use of your product.

 **CAUTION:** A CAUTION indicates either potential damage to hardware or loss of data and tells you how to avoid the problem.

 **WARNING:** A WARNING indicates a potential for property damage, personal injury, or death.

Contents

Safety instructions	5
About your monitor	6
Package contents	6
Product features	7
Operating system compatibility	10
Identifying parts and controls	10
Front view	10
Back view	11
Bottom view	12
Monitor specifications	13
*Dell Display and Peripheral Manager (DDPM) for Windows	14
Resolution specifications	14
Supported video modes	15
Preset display modes	15
Electrical specifications	17
Physical characteristics	18
Environmental characteristics	19
Pin assignments	20
HDMI 19-pin connector	20
USB-C upstream and downstream connector	21
USB Type-A downstream connector	22
Universal Serial Bus (USB) interface	23
Video bandwidth	24
USB speed bandwidth	24
Plug-and-play capability	25
LCD monitor quality and pixel policy	25
Ergonomics	25
Handling and moving your display	27
Maintenance guidelines	28
Cleaning your monitor	28
Setting up the monitor	29
Attaching the stand	29
Using the quick access ports	31
Connecting your monitor	32
Connecting the USB-C to C cable	32
Connecting the HDMI cable (purchased separately)	32
Routing the cables to side I/O (optional)	33
Attaching the side I/O-cover	33
Organizing your cables	33
Removing the monitor stand	34
Wall mounting (optional)	35
Using the tilt, slant and height adjustment	36
Tilt and slant adjustment	36
Height adjustment	36

Operating the monitor	37
Turn on the monitor	37
Using the joystick control	38
Using the On-Screen Display (OSD) menu	39
Accessing the Menu Launcher	39
Using the navigation keys	40
Direct Key functions	41
Accessing the menu system	42
OSD messages	54
Initial Setup	54
OSD warning message	56
Locking the control buttons	59
Setting the maximum resolution	60
Troubleshooting	61
Self-Test	61
Built-in diagnostics	62
Common problems	63
Universal Serial Bus (USB) specific problems	65
Regulatory information	66
FCC notices (U.S. Only) and other regulatory information	66
EU product database for energy label and product information sheet	66
Contacting Dell	67

Safety instructions

Use the following safety guidelines to protect your monitor from potential damage and to ensure your personal safety. Unless otherwise noted, each procedure included in this document assumes that you have read the safety information that is shipped with your monitor.

① **NOTE:** Before using the monitor, read the safety information that is shipped with your monitor and printed on the product. Keep the documentation at a secure location for future reference.

⚠ **WARNING:** Use of controls, adjustments, or procedures other than those specified in this documentation may result in exposure to shock, electrical hazards and/or mechanical hazards.

⚠ **CAUTION:** The possible long-term effect of listening to audio at high volume through the headphones (on a monitor that supports it) may damage your hearing ability.

- Place the monitor on a solid surface and handle it carefully.
 - The screen is fragile and can be damaged if dropped or press with a sharp object.
 - Ensure that your monitor is electrically rated to operate with the AC power available in your location.
 - Keep the monitor in room temperature. Excessive cold or hot conditions can have an adverse effect on the liquid crystal of the display.
 - Connect the power cable from the monitor to a wall outlet that is near and accessible. See [Connecting your monitor](#).
- Do not place and use the monitor on a wet surface or near water.
- Do not subject the monitor to severe vibration or high impact conditions. For example, do not place the monitor inside a car trunk.
- Unplug the monitor when it is going to be left unused for an extended period.
- To avoid electric shock, do not attempt to remove any cover or touch the inside of the monitor.
- Read these instructions carefully. Keep this document for future reference. Follow all warnings and instructions marked on the product.
- Certain monitors can be wall mounted using the VESA mount that is sold separately. Ensure to use the correct VESA specifications as mentioned in the wall mounting section of the User's Guide.

For information about safety instructions, see the Safety, Environmental, and Regulatory Information (SERI) document that is shipped with your monitor.







About your monitor

Package contents

The following table provides the list of components that are shipped with your monitor. If any component is missing, contact Dell. For more information, see [Contacting Dell](#).

NOTE: Some items may be optional and may not ship with your monitor. Some features may not be available in certain countries.

Table 1. Monitor components and descriptions.

Component image	Component description
	Monitor
	Side I/O-Cover
	Stand riser
	Stand base
	USB-C to C 10Gbps 100 W cable 1.0 m
	Power cable (varies by country)
	<ul style="list-style-type: none">• QR card• Safety, Environmental, and Regulatory Information

Product features

The Dell S3425DW monitor has an active matrix, Thin-Film Transistor (TFT), Liquid Crystal Display (LCD), anti-static, and LED backlight. The monitor features include:

- 864.3 mm (34.0 in.) viewable area display (measured diagonally).
- 3440 x 1440 resolution, with full-screen support for lower resolutions.
- Compatible with AMD FreeSync Premium Technology, 120 Hz high refresh rates, and a rapid response time of 1 ms.
- Supports 48 Hz to 120 Hz (HDMI) and 48 Hz to 120 Hz (USB-C Alternate mode) in Freesync Mode.
- Color gamut of sRGB 99% (CIE 1931) (typical) and DCI-P3 95% (CIE 1976) (typical).
- Digital connectivity with two HDMI ports and one USB-C port.
- Supports Picture by Picture (PBP) and Picture in Picture (PIP) Mode.
- Built-in speakers (2 x 5 W).
- Single USB-C supplies power (Power Delivery 65 W) to a compatible laptop while receiving video and data signal.
- Equipped with:
 - One USB-C 5Gbps upstream port (DisplayPort 1.4 Alternate Mode, Power Delivery up to 65 W) - Supports up to 3440 x1440 120 Hz, HDR, AdaptiveSync
 - One USB 5Gbps Type-A downstream port
 - One USB 5Gbps Type-A downstream port with BC 1.2 power-charging
 - One USB-C 5Gbps downstream port (Data only) with charging capability of up to 15 W
- Tilt, slant, and height adjustment capabilities.
- Ultra-thin bezel minimizes the bezel gap in multi-monitor usage, enabling easier setup with an elegant viewing experience.
- Removable stand and Video Electronics Standards Association (VESA) 100 mm mounting holes for flexible mounting solutions.
- Plug-and-play capability (if supported by your computer).
- On-Screen Display (OSD) adjustments for ease of set-up and screen optimization.
- Power and joystick buttons lock.
- Security-lock slot for Kensington locks (sold separately).
- Stand lock.
- ≤0.3 W in Standby Mode.
- Supports Dell Display and Peripheral Manager.
- Dell ComfortView Plus is an integrated low blue light screen feature that improves eye comfort by reducing potentially harmful blue light emissions without compromising color. Through ComfortView Plus technology, Dell has reduced harmful blue light exposure from ≤50% to ≤35%. This monitor is certified with TÜV Rheinland Eye Comfort 3.0 with a 4-star rating. It incorporates key technologies that also deliver a flicker-free screen, up to 120 Hz refresh rate, a color gamut of minimum 95% sRGB. Dell ComfortView Plus feature is enabled by default on your monitor.
- This monitor uses a low blue light panel. When the monitor is reset to factory settings or default setting, it is in compliance with TÜV Rheinland's hardware low blue light certification.*

Blue light ratio:

The ratio of light in the range from 415 nm-455 nm compared to 400 nm-500 nm is less than 50%.

Table 2. Blue light ratio

Category	Blue light ratio
1	≤ 20%
2	20% < R ≤ 35%
3	35% < R ≤ 50%

- Decreases the level of hazard blue light emitted from the screen to make viewing more comfortable for your eyes without distortion of color accuracy.
- The monitor features Flicker-Free technology, eliminating visible flicker to provide a comfortable viewing experience and help prevent eye strain and fatigue.

* This monitor is in compliance with TÜV Rheinland hardware low blue light certification under Category 2.

About TÜV Rheinland Eye Comfort 3.0

TÜV Rheinland Eye Comfort 3.0 certification program presents a consumer-friendly star rating scheme to the display industry thereby promoting eye wellness from safety to eye care. Compared to existing certifications, the 5-star-rating program adds rigorous testing requirements on overall eye care attributes such as low blue-light, flicker-free, refresh rate, color gamut, color accuracy, and ambient light sensor performance. It lays out requirement metrics and rates the product performance on five levels, and the sophisticated technical assessment process provides consumers and buyers with indicators that are easier to judge.

The eye wellness factors being considered remain constant, however, the standards for the various star ratings are different. The higher the star rating, the more stringent the standards. The table below lists the major eye comfort requirements which apply in addition to the basic eye comfort requirements (such as pixel density, uniformity of luminance and color, and freedom of movement).

For more information around **TÜV Eye Comfort certification**, see <https://www.tuv.com/world/en/eye-comfort.html>



Table 3. Eye Comfort 3.0 Requirements and Star Rating Scheme for Monitors

Eye Comfort 3.0 Requirements and Star Rating Scheme for Monitors				
Category	Test item	Star Rating Scheme		
		3-star	4-star	5-star
Eye Care	Low Blue Light	TÜV Hardware LBL Category III ($\leq 50\%$) or Software LBL solution ¹	TÜV Hardware LBL Category II ($\leq 35\%$) or Category I ($\leq 20\%$)	TÜV Hardware LBL Category II ($\leq 35\%$) or Category I ($\leq 20\%$)
	Flicker Free	TÜV Flicker Reduced or TÜV Flicker Free	TÜV Flicker Reduced or TÜV Flicker Free	Flicker Free
Ambient Light Management	Ambient Light Sensor performance	No sensor	No sensor	Ambient light sensor
	Intelligent CCT control	No	No	Yes
	Intelligent Luminance control	No	No	Yes
Image quality	Refresh Rate	≥ 60 Hz	≥ 75 Hz	≥ 120 Hz
	Luminance uniformity	Luminance uniformity $\geq 75\%$		
	Color Uniformity	Color uniformity $\Delta u'v' \leq 0.02$		
	Freedom of movement	Luminance changes shall decrease less than 50%; The color shift shall be less than 0.01.		
	Gamma difference	Gamma difference $\leq \pm 0.2$	Gamma difference $\leq \pm 0.2$	Gamma difference $\leq \pm 0.2$
	Wide color gamut ²	NTSC ³ Min.72% (CIE 1931) or sRGB ⁴ Min 95% (CIE 1931)	sRGB ⁴ Min.95% (CIE 1931)	DCI-P3 ⁵ Min. 95% (CIE 1976) and sRGB ⁴ Min.95% (CIE 1931) or Adobe RGB ⁶ Min.95% (CIE 1931) and sRGB ⁴ Min.95% (CIE 1931)
Eye Comfort User Guide	User guide	Yes	Yes	Yes
Remark	<p>¹ Software controls the blue light emission by reducing excessive blue light, resulting in a more yellow tone.</p> <p>² Color gamut describes the availability of colors in the display. Various standards were developed for specific purposes. 100% corresponds to the full color space as defined in the standard.</p> <p>³ NTSC stands for National Television Standards Committee, which developed a color space for the television system that is used in the United States.</p> <p>⁴ sRGB is a standard red, green, and blue color space that is in use on monitors, printers, and the World Wide Web.</p> <p>⁵ DCI-P3, short for Digital Cinema Initiatives - Protocol 3, is a color space used in digital cinema that encompasses a wider range of colors than the standard RGB color space.</p> <p>⁶ Adobe RGB is a color space which is created by Adobe Systems that encompasses a broader range of colors than the standard RGB color model, particularly in the cyans and greens.</p>			

Operating system compatibility

- Windows 10 and later*
- macOS 13* and macOS 14*

*The operating system compatibility on Dell branded monitors may vary based on factors such as:

- Specific release date(s) when operating system versions, patches, or updates are available.
- Specific release date(s) when Dell branded monitor firmware, software application, or driver updates are available on the Dell support website.

Identifying parts and controls

Front view

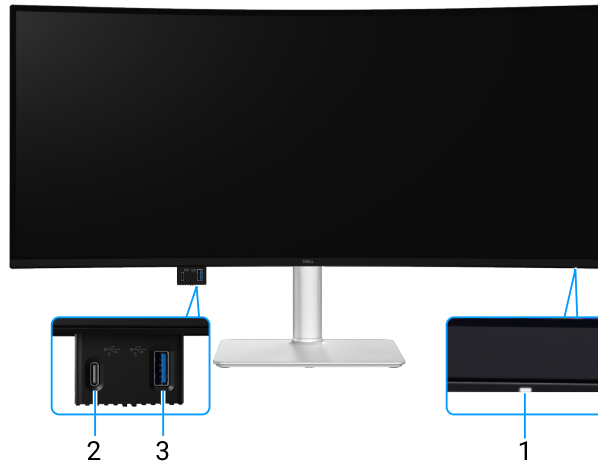



Figure 1. Front view of the monitor

Table 4. Components and descriptions.

Label	Description	Use
1	Power LED indicator	Solid white light indicates that the monitor is turned on and functioning normally. Blinking white light indicates that the monitor is in Standby Mode.
2	 Quick Access Port: USB-C 5Gbps downstream port (data only)	Connect your USB device* or charge your device. NOTE: To use these ports, you must connect the USB-C cable (shipped with your monitor) to the USB-C upstream port on the monitor and to your computer.
3	 Quick Access Port: USB 5Gbps Type-A downstream port	Connect your USB device* or charge your device. NOTE: To use these ports, you must connect the USB-C cable (shipped with your monitor) to the USB-C upstream port on the monitor and to your computer.

* To avoid signal interference, when a wireless USB device has been connected to a USB downstream port, it is NOT recommended to connect any other USB devices to the adjacent port(s).

Back view



Figure 2. Back view of the monitor

Table 5. Components and descriptions.

Label	Description	Use
1	VESA mounting holes (100 mm x 100 mm - behind attached VESA cover)	Wall mount the monitor using VESA-compatible wall mount kit. NOTE: Wall-mount kit is not shipped with your monitor and is sold separately.
2	Regulatory information label	Lists the regulatory approvals.
3	Regulatory label (including MyDell QR code, serial number, and Service Tag label)	See this label if you need to contact Dell for technical support. The Service Tag is a unique alphanumeric identifier that enables Dell service technicians to identify the hardware components in your monitor and access warranty information.
4	Joystick	Use to control the OSD menu. For more Information, see Operating the monitor .
5	Power button	To turn the monitor on or off.
6	Stand release button	Releases the stand from the monitor.
7	Side I/O cover	Use to cover side I/O.
8	Cable management guide	Use to organize cables by routing them through the slot.

Bottom view

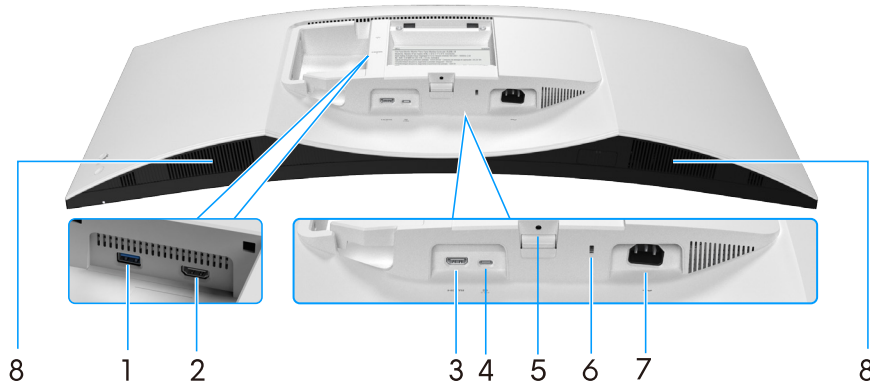







Figure 3. Bottom view of the monitor

Table 6. Components and descriptions.

Label	Description	Use
1	 USB 5Gbps Type-A downstream port	Connect your USB device or charge your device. NOTE: To use these ports, you must connect the USB-C cable (shipped with your monitor) to the USB-C upstream port on the monitor and to your computer.
2	 HDMI 2 port	Connect your computer with the HDMI cable (purchased separately).
3	 HDMI 1 port	Connect your computer with the HDMI cable (purchased separately).
4	 USB-C 5Gbps upstream port (Power Delivery up to 65 W)	Connect the USB-C cable that came with your monitor to the computer or mobile device. This port supports Video, Power, and Data. The USB-C 5Gbps upstream port supports DisplayPort 1.4 Alternate Mode with a maximum resolution of 3440 x 1440 at 120 Hz, PD 20 V/ 3.25 A, 15 V/3 A, 9 V/3 A, 5 V/3 A. NOTE: USB-C is not supported on versions of Windows prior to Windows 10.
5	Stand-lock feature	Lock the stand to the monitor using a M3 x 6 mm screw (screw not included).
6	Security-lock slot (based on Kensington Security Slot)	Secure your monitor using a security lock (purchased separately) to prevent unauthorized movement of your monitor.
7	 Power connector	Connect the power cable (shipped with your monitor).
8	Built-in speakers	Provides audio output.

Monitor specifications

Table 7. Monitor specifications.

Description	Value
Screen type	Active matrix - TFT LCD
Panel technology	Vertical Alignment (VA) Technology
Aspect ratio	21:9
Viewable image dimensions	
Diagonal	864.3 mm (34.0 in.)
Active area	
Horizontal	797.22 mm (31.39 in.)
Vertical	333.72 mm (13.14 in.)
Area	266048.26 mm ² (412.38 in. ²)
Pixel pitch	
Horizontal	0.23175 mm
Vertical	0.23175 mm
Pixel per inch (PPI)	109
Viewing angle	
Horizontal	178° (typical)
Vertical	178° (typical)
Brightness	300 cd/m ² (typical)
Contrast ratio	3000:1 (typical)
Display screen coating	Anti-glare with hard-coating 3H
Backlight	LED Edgelight System
Response time	<ul style="list-style-type: none"> • Normal mode: 5 ms (gray to gray) • Fast mode: 3 ms (gray to gray) • Extreme mode: 1 ms (gray to gray)
Color depth	1.07 billion colors
Color gamut	<ul style="list-style-type: none"> • sRGB 99% (CIE 1931) (typical) • DCI-P3 95% (CIE 1976) (typical)
Connectivity	<p>Rear:</p> <ul style="list-style-type: none"> • Two HDMI 2.1 (HDCP 1.4 and 2.2) - Supports up to WQHD 3440 x 1440, 120 Hz, 10 bit, FRL, HDR, VRR as per specified in HDMI 2.1 • One USB-C 5Gbps upstream port (DisplayPort 1.4 Alternate Mode, Power Delivery up to 65W) - Supports up to 3440 x 1440, 120 Hz, HDR, AdaptiveSync • One USB 5Gbps Type-A downstream port <p>Quick access (bottom left):</p> <ul style="list-style-type: none"> • One USB 5Gbps Type-A downstream port with BC 1.2 power-charging • One USB-C 5Gbps downstream port (Data only) with charging capability of up to 15 W
Border width (edge of monitor to active area)	
Top	8.25 mm (0.33 in.)
Left/Right	8.29 mm (0.33 in.)
Bottom	13.80 mm (0.54 in.)

Description	Value
Adjustability	
Height adjustable stand	130 mm
Tilt	-5° to 21°
Swivel	Not available
Slant adjust	-4° to 4°
Cable management	Yes
Dell Display and Peripheral Manager*	Yes
Security	Security-lock slot (for Kensington locks, sold separately)
Built-in speakers	2 x 5 W

*Dell Display and Peripheral Manager (DDPM) for Windows

DDPM is a software application that helps you set up and configure the Dell monitors and peripherals. Some of its features include:

1. Adjusting the monitor On-Screen Display (OSD) settings such as brightness, contrast, and resolution without needing to use the joystick on the monitor.
2. Arrange multiple applications on your screen by placing them into a template of your choice using **Easy Arrange**.
3. Assign applications or files to the partitions of **Easy Arrange**, save the layout as a profile, and restore the profile automatically with **Easy Arrange Memory** when needed.
4. Connect the Dell Monitor to multiple input sources and manage these video inputs using the **Input Source** feature.
5. Customize each application with its own distinct color mode using the **Color Preset** feature.
6. Replicate software application settings from one monitor to another identical monitor using the **Import/Export** application settings feature.
7. Receive notifications and update the firmware and software.
8. Also, if the display supports the **Network KVM** feature, then you can share the keyboard and mouse across computers on the same network and transfer files between them.
9. A macOS version of DDPM software is also available for your monitor. For the list of displays that support DDPM macOS version, see the knowledge base article 000201067 at [Dell Support Site](#).

NOTE: Some features of the DDPM mentioned above are available only on select monitor models. For more information about DDPM, and the recommended computer configuration to install it, go to [Dell Support Site](#).

Resolution specifications

Table 8. Resolution specifications

Description	Value
Horizontal scan range	25 kHz to 200 kHz (automatic)
Vertical scan range	48 Hz to 120 Hz (automatic)
Maximum preset resolution	3440 x 1440 at 120 Hz

Supported video modes

Table 9. Supported video modes

Description	Value
Video display capabilities (HDMI)	480p, 576p, 720p, 1080i, 1080p, 1440p, 2160p
Video display capabilities (USB-C)	480p, 576p, 720p, 1080p, 1440p

Preset display modes

Table 10. HDMI preset display modes

Display Mode	Horizontal Frequency (kHz)	Vertical Frequency (Hz)	Pixel Clock (MHz)	Sync Polarity (Horizontal/Vertical)
IBM 720 x 400	31.47	70.08	28.32	-/+
VESA 640 x 480	31.47	59.94	25.18	-/-
VESA 640 x 480	37.50	75.00	31.50	-/-
VESA 800 x 600	37.88	60.32	40.00	+/+
VESA 800 x 600	46.88	75.00	49.50	+/+
VESA 1024 x 768	48.36	60.00	65.00	-/-
VESA 1024 x 768	60.02	75.03	78.75	+/+
VESA 1152 x 864	67.50	75.00	108.00	+/+
VESA 1280 x 720	45.00	59.94	74.25	-/+
VESA 1280 x 800	49.31	59.91	71.00	+/+
VESA 1440 x 900	55.94	59.89	106.50	-/+
VESA 1280 x 960	60.00	60.00	108.00	+/+
VESA 1280 x 1024	63.98	60.02	108.00	+/+
VESA 1680 x 1050	65.29	59.95	146.25	-/+
VESA 1920 x 1080	67.50	60.00	148.50	+/+
VESA 2560 x 1440	183.00	120.00	497.50	+/-
VESA 3440 x 1440	88.82	59.97	319.75	+/-
VESA 3440 x 1440	151.00	99.98	538.37	+/-
VESA 3440 x 1440	183.00	120.00	666.12	+/-
VESA 3840 x 2160	133.31	60.00	533.25	+/-
VESA 3840 x 2160	183.00	120.00	666.12	+/-

Table 11. USB-C preset display modes

Display Mode	Horizontal Frequency (kHz)	Vertical Frequency (Hz)	Pixel Clock (MHz)	Sync Polarity (Horizontal/Vertical)
IBM 720 x 400	31.47	70.08	28.32	-/+
VESA 640 x 480	31.47	59.94	25.18	-/-
VESA 640 x 480	37.50	75.00	31.50	-/-
VESA 800 x 600	37.88	60.32	40.00	+/+
VESA 800 x 600	46.88	75.00	49.50	+/+
VESA 1024 x 768	48.36	60.00	65.00	-/-
VESA 1024 x 768	60.02	75.03	78.75	+/+
VESA 1152 x 864	67.50	75.00	108.00	+/+
VESA 1280 x 720	45.00	59.94	74.25	-/+
VESA 1280 x 800	49.31	59.91	71.00	+/+
VESA 1440 x 900	55.94	59.89	106.50	-/+
VESA 1280 x 960	60.00	60.00	108.00	+/+
VESA 1280 x 1024	63.98	60.02	108.00	+/+
VESA 1680 x 1050	65.29	59.95	146.25	-/+
VESA 1920 x 1080	67.50	60.00	148.50	+/+
VESA 2560 x 1440	183.00	120.00	497.50	+/-
VESA 3440 x 1440	88.82	59.97	319.75	+/-
VESA 3440 x 1440	151.00	99.98	538.37	+/-
VESA 3440 x 1440	183.00	120.00	666.12	+/-

NOTE: The monitor also supports other display resolutions that are not listed in the preset mode.

Electrical specifications

Table 12. Electrical specifications

Description	Value
Video input signals	HDMI 2.1/USB-C (DP 1.4 Alt Mode), 600 mV for each differential line, 100 ohm input impedance per differential pair.
AC input voltage/frequency/ current	100 VAC-240 VAC/50 Hz or 60 Hz ± 3 Hz/2 A (typical)
Inrush current	120 V: 30 A (maximum) at 0°C (cold start) 240 V: 60 A (maximum) at 0°C (cold start)
Power consumption	0.3 W (Off mode) ¹ 0.3 W (Standby Mode) ¹ 31.0 W (On Mode) ¹ 175 W (Maximum) ² 33.0 W (P _{on}) ³ 102.9 kWh (TEC) ³

¹ As defined in EU 2019/2021 and EU 2019/2013.

² Max brightness and contrast setting with maximum power loading on all USB ports.

³ P_{on}: Power consumption of On mode as defined in Energy Star 8.0 version.

TEC: Total energy consumption in kWh as defined in Energy Star 8.0 version.

This document is for informational purposes only and reflects laboratory performance. Your product's performance may vary based on the software, components, and peripherals you have ordered. There is no obligation to update this information.

Accordingly, the customer should not rely upon this information in making decisions about electrical tolerances or otherwise. No warranty as to accuracy or completeness is expressed or implied.

NOTE: This monitor is ENERGY STAR certified.

ENERGY STAR is a program run by the U.S. Environmental Protection Agency (EPA) and the U.S. Department of Energy (DOE) that promotes energy efficiency.

This product qualifies for ENERGY STAR in the factory default settings, and this is the setting in which power savings is achieved.

Changing the factory default picture settings or enabling other features increases the power consumption that could exceed the limits necessary to qualify for an ENERGY STAR rating.

For more information about the ENERGY STAR program, go to <https://www.energystar.gov>.



Physical characteristics

Table 13. Physical characteristics

Description	Value
Signal cable type	Universal Series Bus: Type-C, 24 pins Digital: HDMI port, 19 pins (cable not included)
Dimensions (with stand)	
Height (extended)	517.18 mm (20.36 in.)
Height (compressed)	411.53 mm (16.20 in.)
Width	807.32 mm (31.78 in.)
Depth	221.85 mm (8.73 in.)
Dimensions (without stand)	
Height	355.77 mm (14.01 in.)
Width	807.32 mm (31.78 in.)
Depth	116.89 mm (4.60 in.)
Stand dimensions	
Height (extended)	410.30 mm (16.15 in.)
Height (compressed)	371.90 mm (14.64 in.)
Width	259.00 mm (10.20 in.)
Depth	221.85 mm (8.73 in.)
Weight	
Weight with packaging	14.88 kg (32.80 lb)
Weight with stand assembly and cables	9.38 kg (20.68 lb)
Weight without stand assembly (no cables)	6.91 kg (15.23 lb)
Weight of stand assembly	2.22 kg (4.89 lb)

Environmental characteristics

Table 14. Environmental characteristics

Description	Value
Compliant Standards	<ul style="list-style-type: none"> • ENERGY STAR certified monitor • RoHS-compliant • BFR/PVC reduce monitor (Circuit boards are made from BFR/PVC-free laminates). • Arsenic-free glass and Mercury-free for the panel only
Temperature	
Operating	0°C to 40°C (32°F to 104°F)
Non-operating	Storage: -20°C to 60°C (-4°F to 140°F) Shipping: -20°C to 60°C (-4°F to 140°F)
Humidity	
Operating	10% to 80% (non-condensing)
Non-operating	Storage: 5% to 90% (non-condensing) Shipping: 5% to 90% (non-condensing)
Altitude	
Operating (maximum)	5,000 m (16,400 ft)
Non-operating (maximum)	12,191 m (40,000 ft)
Thermal dissipation	598.5 BTU/hour (Maximum) 112.9 BTU/hour (On Mode)

Pin assignments

HDMI 19-pin connector

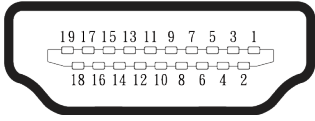

Figure 4. HDMI 19-pin connector

Table 15. Pin assignments - HDMI 1/HDMI 2

Pin number	19-pin side of the connected signal cable
1	TMDS DATA 2+
2	TMDS DATA 2 SHIELD
3	TMDS DATA 2-
4	TMDS DATA 1+
5	TMDS DATA 1 SHIELD
6	TMDS DATA 1-
7	TMDS DATA 0+
8	TMDS DATA 0 SHIELD
9	TMDS DATA 0-
10	TMDS CLOCK+
11	TMDS CLOCK SHIELD
12	TMDS CLOCK-
13	CEC
14	Reserved (N.C. on device)
15	DDC CLOCK (SCL)
16	DDC DATA (SDA)
17	DDC/CEC Ground
18	+5 V POWER
19	HOT PLUG DETECT

USB-C upstream and downstream connector

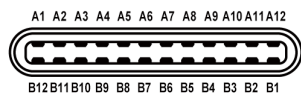

Figure 5. USB-C connector

Table 16. Pin assignments - USB-C connector

Pin number	Signal name	Pin number	Signal name
A1	GND	B1	GND
A2	TX1+	B2	TX2+
A3	TX1-	B3	TX2-
A4	VBUS	B4	VBUS
A5	CC1	B5	CC2
A6	D+	B6	D+
A7	D-	B7	D-
A8	SBU1	B8	SBU2
A9	VBUS	B9	VBUS
A10	RX2-	B10	RX1-
A11	RX2+	B11	RX1+
A12	GND	B12	GND

USB Type-A downstream connector

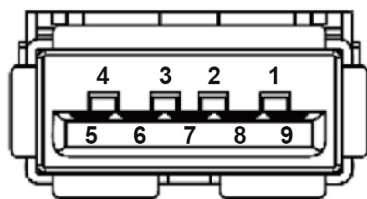

Figure 6. USB Type-A downstream connector

Table 17. Pin assignments - USB Type-A downstream connector

Pin number	9-pin side of the connector
1	VCC
2	D-
3	D+
4	GND
5	SSRX-
6	SSRX+
7	GND
8	SSTX-
9	SSTX+

Universal Serial Bus (USB) interface

This section provides information about the USB ports that are available on the monitor.

Rear

- One USB-C 5Gbps upstream

Table 18. USB-C 5Gbps upstream

USB-C	Description
Video	DisplayPort 1.4*
Data	5Gbps
Power Delivery (PD)	Up to 65 W

*HBR3 is supported.

- One USB 5Gbps Type-A downstream

Table 19. USB 5Gbps Type-A downstream

Transfer speed	Data rate	Maximum power supported
USB 5Gbps	5 Gbps	4.5 W
USB 2.0	480 Mbps	4.5 W
USB 1.0	12 Mbps	4.5 W

Quick access (bottom left)

- One USB 5Gbps Type-A downstream with BC 1.2 power-charging

Table 20. USB 5Gbps Type-A downstream

Transfer speed	Data rate	Maximum power supported
USB 5Gbps	5 Gbps	10 W
USB 2.0	480 Mbps	10 W
USB 1.0	12 Mbps	10 W

- One USB-C 5Gbps downstream

Table 21. USB-C 5Gbps downstream

Transfer speed	Data rate	Maximum power supported
USB 5Gbps	5 Gbps	15 W
USB 2.0	480 Mbps	15 W
USB 1.0	12 Mbps	15 W

NOTE: 5Gbps data rate requires a USB 5Gbps-capable computer.

NOTE: The USB ports on the monitor work only when the monitor is turned on or is in standby mode. If you turn off the monitor and then turn it on, the attached peripherals may take a few seconds to resume normal functionality.

Video bandwidth

Table 22. Video bandwidth

Host	Video cable	DSC	Color depth	USB-C prioritization	Max resolution and refresh rate
USB-C (DP 1.4 Alt Mode)	USB-C cable	DSC ON	10 Bit	High Data Speed	3440 x 1440 at 120 Hz
		DSC ON	10 Bit	High Resolution	3440 x 1440 at 120 Hz
		DSC OFF	10 Bit	High Data Speed	3440 x 1440 at 60 Hz
		DSC OFF	10 Bit	High Resolution	3440 x 1440 at 120 Hz
HDMI 2.1	HDMI 2.1 cable	N/A	10 Bit	N/A	3440 x 1440 at 120 Hz

NOTE: Color depth and resolution may change depending on the behavior of the host.

USB speed bandwidth

Table 23. USB speed bandwidth

Host	USB upstream cable	USB-C prioritization	Maximum data rate supported
USB-C (DP 1.2 Alt Mode)	USB-C cable (included with your monitor)	High Data Speed	5 Gbps
		High Resolution	480 Mbps
USB-C (DP 1.4 Alt Mode)	USB-C cable (included with your monitor)	High Data Speed	5 Gbps
		High Resolution	480 Mbps
USB 2.0 Type-A	USB Type-C to Type-A cable	N/A	480 Mbps
USB 5Gbps Type-A	USB Type-C to Type-A cable	N/A	5 Gbps
USB-C 5Gbps (data only)	USB-C cable (included with your monitor)	N/A	5 Gbps
USB-C 10Gbps (data only)	USB-C cable (included with your monitor)	N/A	5 Gbps

Plug-and-play capability

You can connect the monitor to any Plug and Play-compatible system. The monitor automatically provides the computer with its Extended Display Identification Data (EDID) using Display Data Channel (DDC) protocols so that the computer can configure itself and optimize the monitor settings. Most monitor installations are automatic; you can select different settings as required. For more information about changing the monitor settings, see [Operating the monitor](#).

LCD monitor quality and pixel policy

During the LCD Monitor manufacturing process, it is not uncommon for one or more pixels to become fixed in an unchanging state which are hard to see and do not affect the display quality or usability. For more information on Dell Monitor Quality and Pixel Policy, see www.dell.com/pixelguidelines.

Ergonomics

△ CAUTION: Improper or prolonged usage of a keyboard may result in injury.

△ CAUTION: Viewing the monitor screen for extended periods of time may result in eye strain.

For comfort and efficiency, observe the following guidelines when setting up and using your computer workstation:

- Position your computer so that the monitor and keyboard are directly in front of you as you work. Special shelves are commercially available to help you correctly position your keyboard.
- To reduce the risk of eye strain and neck, arm, back, or shoulder pain from using the monitor for a long period, we recommend you to:
 - Set the distance of the screen between 20 to 28 in. (50 - 70 cm) from your eyes.
 - Blink frequently to moisten your eyes or wet your eyes with water after prolonged usage of the monitor.
 - Take regular and frequent breaks for 20 minutes every two hours.
 - Look away from your monitor and gaze at a distant object that is 20 feet away for at least 20 seconds during the breaks.
 - Perform stretches to relieve tension in the neck, arms, back, and shoulders during the breaks.
- Ensure that the monitor screen is at the eye level or slightly lower when you are sitting in front of the monitor.
- Adjust the tilt of the monitor, its contrast, and brightness settings.
- Adjust the ambient lighting around you (such as overhead lights, desk lamps, and the curtains, or blinds on nearby windows) to minimize reflections and glare on the monitor screen.
- Use a chair that provides good lower back support.
- Keep your forearms horizontal with your wrists in a neutral, comfortable position while using the keyboard or mouse.
- Always leave space to rest your hands while using the keyboard or mouse.
- Let your upper arms rest naturally on both sides.
- Ensure that your feet are resting flat on the floor.
- When sitting, make sure that the weight of your legs is on your feet and not on the front portion of your seat. Adjust your chair height or use a footrest if necessary to maintain a proper posture.
- Vary your work activities. Try to organize your work so that you do not have to sit and work for extended periods of time. Try to stand or get up and walk around at regular intervals.
- Keep the area under your desk clear of obstructions and cables or power cords that may interfere with comfortable seating or present a potential trip hazard.

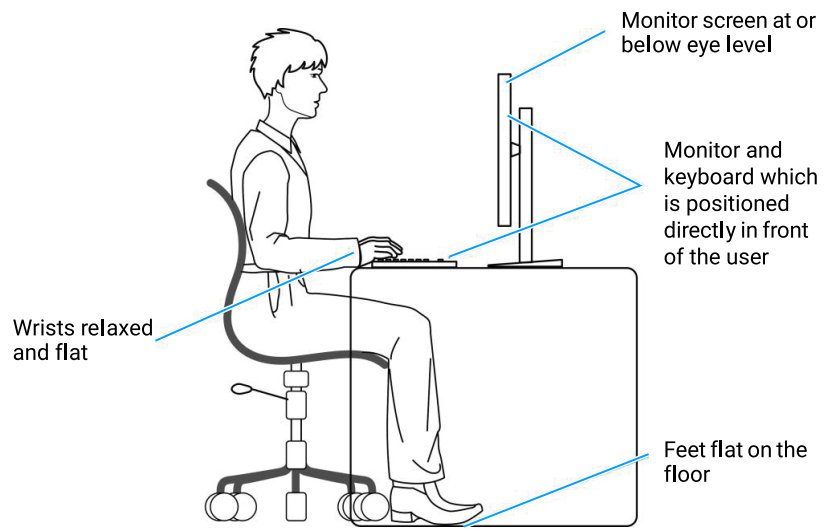

Figure 7. Ergonomics

Handling and moving your display

To ensure that the monitor is handled safely when lifting or moving it, follow these guidelines:

- Before moving or lifting the monitor, turn off your computer and the monitor.
- Disconnect all cables from the monitor.
- Place the monitor in the original box with the original packing materials.
- Hold the bottom edge and the side of the monitor firmly without applying excessive pressure when lifting or moving the monitor.

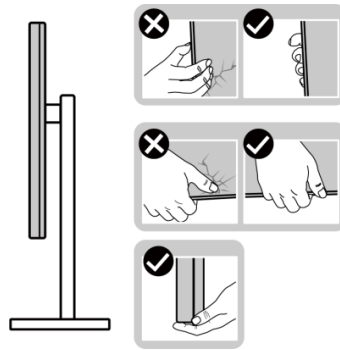

Figure 8. Handling the display

- When lifting or moving the monitor, ensure that the screen is facing away from you and do not press on the display area to avoid any scratches or damage.

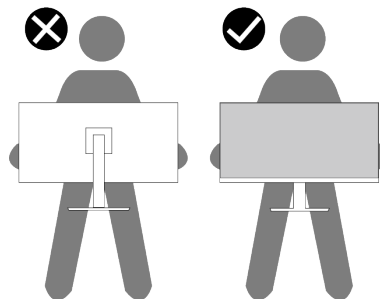

Figure 9. The screen is facing away from you

- When transporting the monitor, avoid any sudden shock or vibration to it.
- When lifting or moving the monitor, do not turn the monitor upside down while holding the stand base or stand riser. It may result in accidental damage to the monitor or cause personal injury.

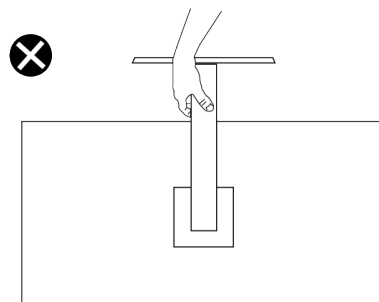

Figure 10. Do not turn the monitor upside down

Maintenance guidelines

Cleaning your monitor

⚠ CAUTION: Read and follow the [Safety instructions](#) before cleaning the monitor.

⚠ WARNING: Before cleaning the monitor, unplug the monitor power cable from the electrical outlet.

For best practices, follow the instructions in the list below when unpacking, cleaning, or handling your monitor:

- Use a clean cloth that is slightly dampened with water to clean the stand assembly, the screen, and the chassis of your Dell monitor. If available, use a screen-cleaning tissue or solution suitable for cleaning Dell monitors.
- After cleaning the surface of the table, ensure that it is thoroughly dry and free from any moisture or cleaning agent before placing your Dell monitor on it.
- ⚠ **CAUTION:** Do not use detergents or other chemicals such as benzene, thinner, ammonia, abrasive cleaners, alcohol, or compressed air.
- ⚠ **CAUTION:** Using chemicals for cleaning may cause changes in the appearance of the monitor, such as color fading, milky film on the monitor, deformation, uneven dark shade, and peeling of screen area.
- ⚠ **WARNING:** Do not spray the cleaning solution or even water directly on the surface of the monitor. Doing so will allow liquids to accumulate at the bottom of the display panel and corrode the electronics resulting in permanent damage. Instead, apply the cleaning solution or water to a soft cloth and then clean the monitor.
- ⓘ **NOTE:** Monitor damage due to improper cleaning methods and the use of benzene, thinner, ammonia, abrasive cleaners, alcohol, compressed air, detergent of any kind leads to a Customer Induced Damage (CID). CID is not covered under the standard Dell warranty.
- If you notice white residual powder when you unpack your monitor, wipe it off with a cloth.
- Handle your monitor with care as a darker-colored monitor may get scratched and show white scuff marks more than a lighter-colored monitor.
- To help maintain the best image quality on your monitor, use a dynamically changing screen saver and turn off your monitor when not in use.

Setting up the monitor

Attaching the stand

- ① **NOTE:** The stand is not installed at the factory when shipped.
- ① **NOTE:** The following instructions are applicable only for the stand that was shipped with your monitor. If you are attaching a stand that you purchased from any other source, follow the setup instructions that were included with the stand.

To attach the monitor stand:

1. Remove the stand riser and stand base from the packaging cushion.

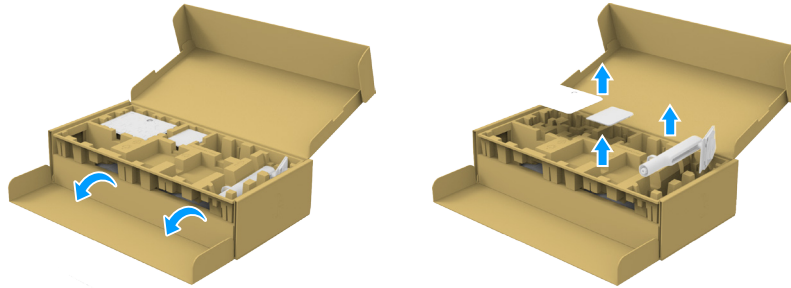

Figure 11. Remove the stand riser and stand base

- ① **NOTE:** The images are for the purpose of illustration only. The placement and appearance of the package cushion may vary by model.

2. Insert the stand base blocks fully into the stand slot.
3. Lift the screw handle and turn the screw clockwise.
4. After fully tightening the screw, fold the screw handle flat within the recess.

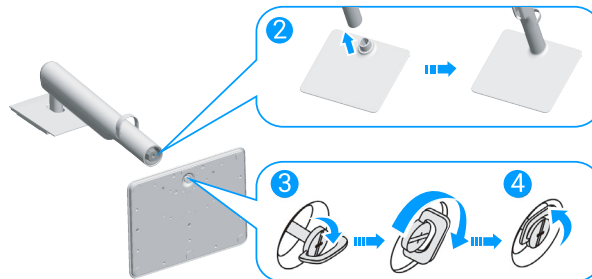

Figure 12. Install the stand riser and stand base

5. Lift the protective cover, as shown, to access the VESA area for stand assembly.



Figure 13. Lift the protective cover

- ① **NOTE:** Ensure that the front plate flap is fully opened before attaching the stand assembly to the display.

6. Attach the stand assembly to the display.
 - Fit the two tabs on the upper part of the stand to the groove on the back of the display.
 - Press the stand down till it snaps into place.

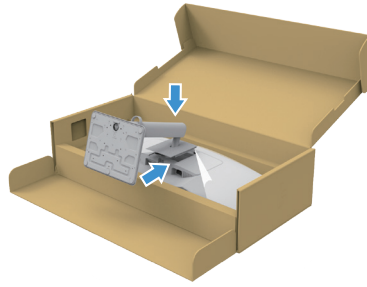

Figure 14. Attach the stand assembly to the display

7. Hold the stand riser and lift the monitor carefully, then place it on a flat surface.

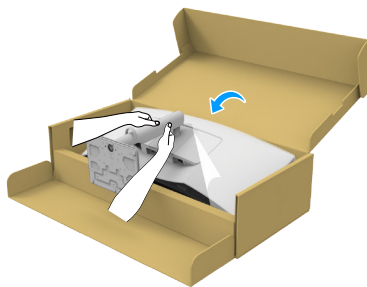

Figure 15. Hold the stand riser and lift the monitor

NOTE: Lift the monitor carefully to prevent it from slipping or falling.

8. Remove the cover from the monitor.

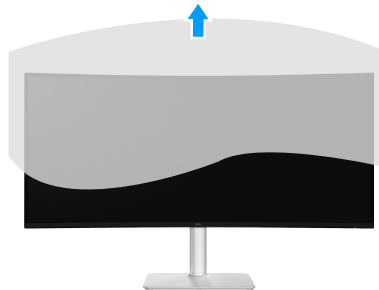

Figure 16. Remove the cover from the monitor

Using the quick access ports

When you want to use the monitor's built-in quick access ports, press on the quick access ports module and then release. The quick access ports module slides down.

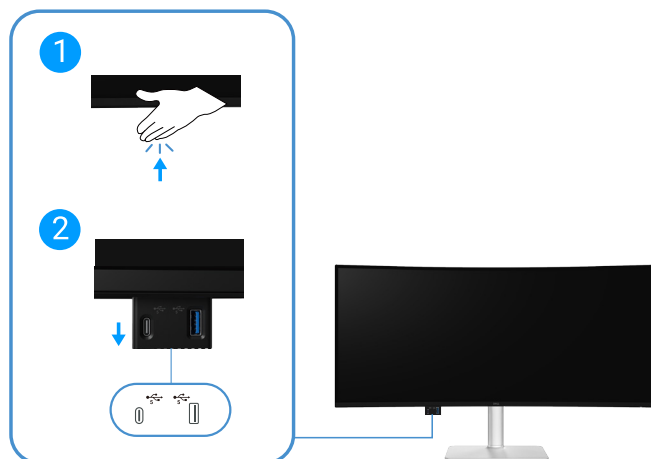

Figure 17. Using the quick access ports

Connecting your monitor

⚠ WARNING: Before you begin any of the procedures in this section, follow the [Safety instructions](#).

ⓘ NOTE: Dell monitors are designed to work optimally with the Dell-supplied cables inside the box. Dell does not guarantee the video quality and performance if non-Dell cables are used.

ⓘ NOTE: Route the cables through the cable management guide before connecting them.

ⓘ NOTE: Do not connect all the cables to the computer at the same time.

ⓘ NOTE: The images are for the purpose of illustration only. The appearance of the computer may vary.

To connect your monitor to the computer:

1. Turn off your computer and disconnect the power cable.
2. Connect the USB-C or HDMI cable (purchased separately) from your monitor to the computer.

Connecting the USB-C to C cable

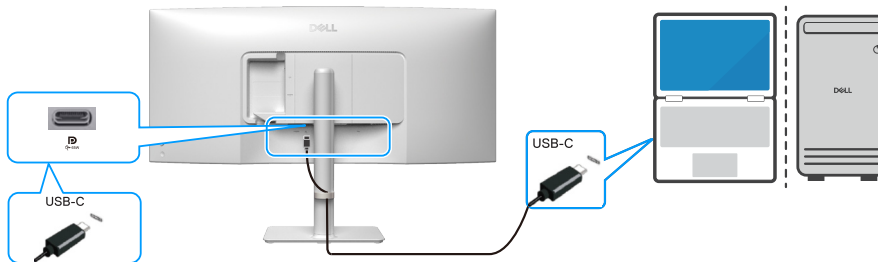

Figure 18. Connecting the USB-C to C cable

Connecting the HDMI cable (purchased separately)

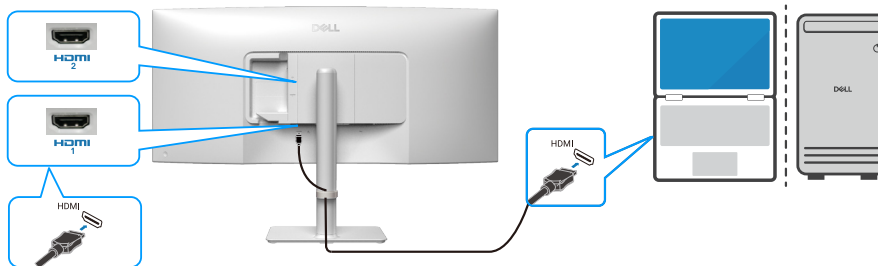

Figure 19. Connecting the HDMI cable

3. Plug the power cables from your computer and monitor into a nearby outlet.

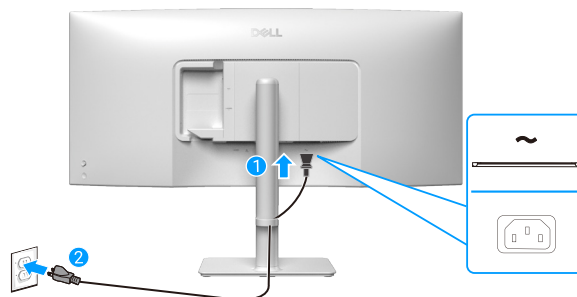

Figure 20. Connecting the power cable

4. Turn on the monitor and the computer.

If your monitor displays an image, installation is complete. If it does not display an image, see [Common problems](#).

Routing the cables to side I/O (optional)

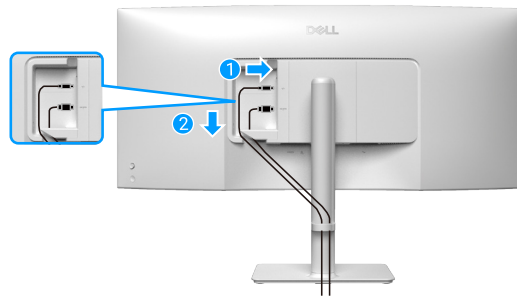

Figure 21. Routing the cables to side I/O

To route the cables to the side I/O:

1. Insert the HDMI cable (purchased separately) and USB cable (purchased separately) into the side I/O connector.
2. Insert and organize the cables under the restraint lever as shown above.

Attaching the side I/O-cover

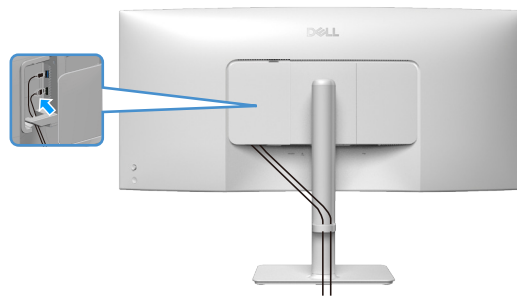

Figure 22. Attaching the side I/O-cover

To attach the side I/O-cover:

1. Align and place the tabs on the side I/O-cover with the slots on the display back-cover.
2. Press the side I/O-cover to snap it into place.

Organizing your cables

Route the cables through the cable management guide on the stand riser.



Figure 23. Organizing your cables

After connecting all necessary cables to your monitor and computer, (see [Connecting your monitor](#) for cable attachment) organize all cables as shown in the image.

If your cable is not able to reach your computer, you may connect directly to the computer without routing through the cable management guide on the monitor stand.

Securing your monitor using Kensington lock (optional)

The security-lock slot is located at the bottom of the monitor (see [Security-lock slot](#)). Secure your monitor to a table using the Kensington security lock.

For more information on using the Kensington lock (sold separately), see the documentation that is shipped with the lock.

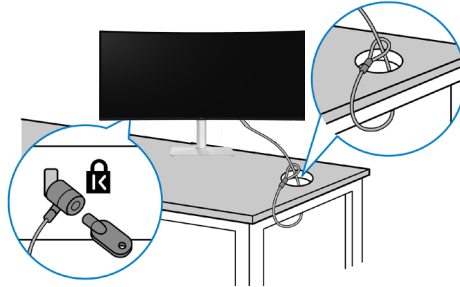

Figure 24. Using Kensington lock

NOTE: The image is for the purpose of illustration only. The appearance of the lock may vary.

Removing the monitor stand

NOTE: To prevent scratches on the LCD screen when removing the stand, ensure that the monitor is placed on a soft surface and handle it carefully.

NOTE: The following steps are specifically for removing the stand that is shipped with your monitor. If you are removing a stand that you purchased from any other source, follow the setup instructions that are included with the stand.

NOTE: Before removing the stand, ensure that you have disconnected all the cables from the monitor.

To remove the stand:

1. Place the monitor on a soft cloth or cushion.
2. Press and hold the stand release button at the back of the display.
3. Lift the stand assembly up and away from the monitor.

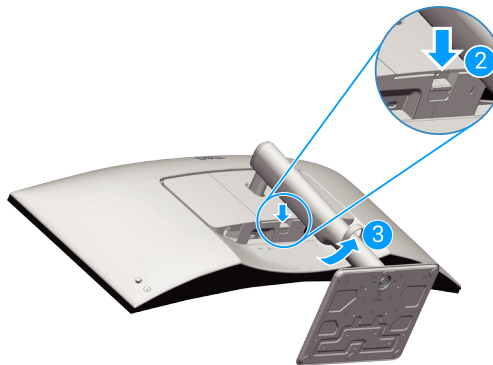

Figure 25. Removing the monitor stand

Wall mounting (optional)

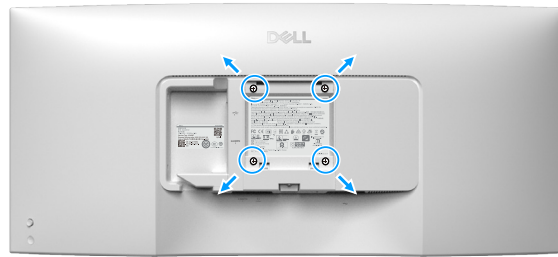

Figure 26. Wall mounting

NOTE: Use M4 x 10 mm screws to connect the monitor to the wall mounting kit.

See the documentation that is shipped with the VESA-compatible wall mounting kit.

1. Place the monitor panel on a soft cloth or cushion on a stable flat table.
2. Remove the stand (see [Removing the monitor stand](#)).
3. Using a Phillips crosshead screwdriver, remove the four screws securing the plastic cover.
4. Attach the mounting bracket from the wall mounting kit to the monitor.
5. Mount the monitor on the wall. For more information, see the documentation that is shipped with the wall mounting kit.

NOTE: Mount the monitor using only UL/CSA/GS-listed wall mount bracket with minimum weight or load-bearing capacity (27.64 kg).

Using the tilt, slant and height adjustment

① **NOTE:** The following instructions are applicable only for attaching the stand that was shipped with your monitor. If you are attaching a stand that you purchased from any other source, follow the setup instructions that were included with the stand.

Tilt and slant adjustment

With the stand attached to the monitor, you can tilt and slant the monitor for the most comfortable viewing angle.

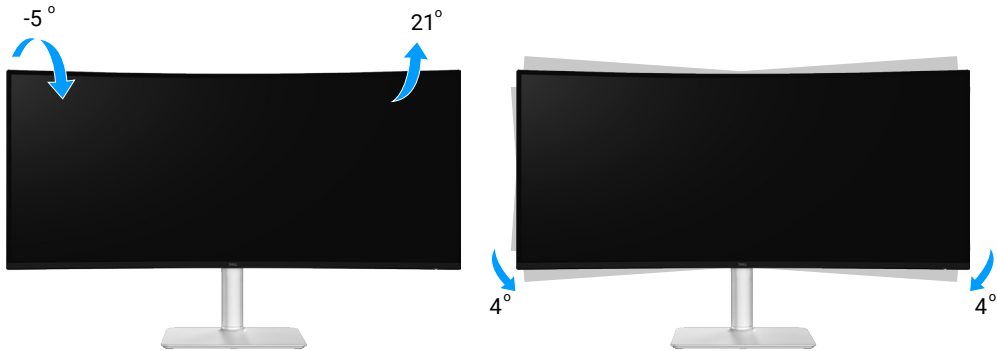

Figure 27. Tilt and slant adjustment

① **NOTE:** The stand assembly is not pre-installed when the monitor is shipped from the factory.

Height adjustment

① **NOTE:** The stand can extend vertically up to 130 mm.

The following image illustrates how to extend the stand vertically.

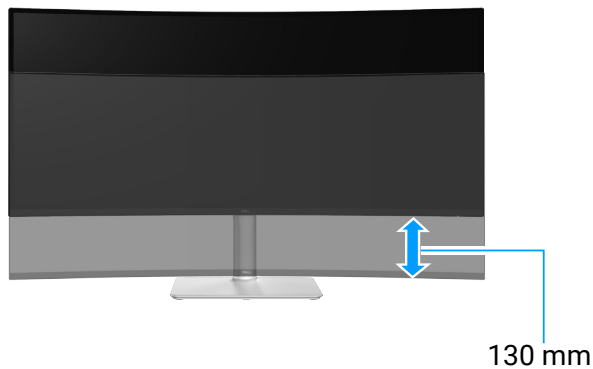

Figure 28. Height adjustment

Operating the monitor

⚠ CAUTION: Before using the monitor, it is recommended to fasten the stand riser to a wall using cable tie or a cord that can support the weight of the monitor in order to prevent the monitor from falling.

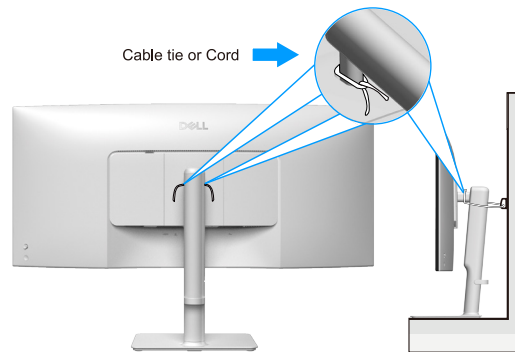

Figure 29. Fasten the monitor

Turn on the monitor

Press the power button to turn on the monitor.



Figure 30. Turn on the monitor

Using the joystick control

Use the joystick control on the rear of the monitor to make On-Screen Display (OSD) adjustments.

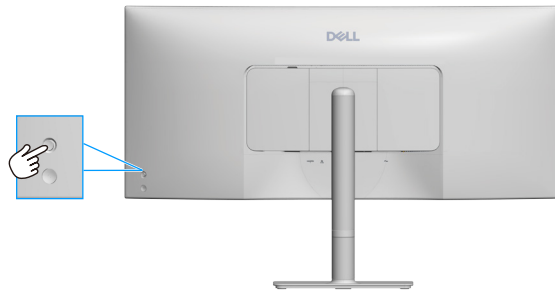

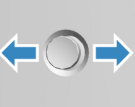



Figure 31. Using the joystick control

1. Press the joystick to launch the Menu Launcher.
2. Adjust the joystick in any direction-up, down, left, or right-to navigate through the options.
3. Press the joystick again to confirm the selection.

Table 24. Using the joystick control

Joystick	Description
	<p>When there is no OSD on the screen, press the joystick to launch the Menu Launcher. See Accessing the Menu Launcher.</p> <p>When the OSD is displayed, press the joystick to confirm the selection or save the settings.</p>
	<p>For two way (right and left) directional navigation.</p> <p>Move right to enter the submenu.</p> <p>Move left to the upper-level menu or exit from the current menu.</p>
	<p>For two way (up and down) directional navigation.</p> <p>Navigates between the menu items.</p> <p>Increases (up) or decreases (down) the parameters of selected menu item.</p>

Using the On-Screen Display (OSD) menu

Accessing the Menu Launcher

When you press the joystick, the Menu Launcher appears to let you access the OSD main menu and shortcut functions.

To select a function, move the joystick.

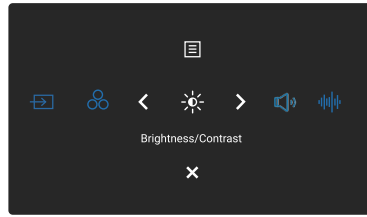









Figure 32. Accessing the Menu Launcher

Table 25. Describes the Menu Launcher functions:

	Joystick	Description
1	 Shortcut key 1 / Input Source	To choose an input source from the listed video signals.
2	 Shortcut key 2 / Preset Modes	To choose a preferred color mode from the list of preset modes.
3	 Shortcut key 3 / Brightness/Contrast	To access the adjustment sliders of brightness and contrast.
4	 Shortcut key 4 / Volume	To access the adjustment slider of Volume.
5	 Shortcut key 5 / Audio Profiles	To choose a preferred audio mode from the list of audio profiles.
6	 Menu	To launch the On-Screen Display (OSD) main menu. See Accessing the menu system .
7	 Exit	To exit the Menu Launcher.





Using the navigation keys

When the OSD main menu is active, move the joystick to configure the settings, following the navigation keys displayed below the OSD.



Figure 33. Navigation keys

Table 26. Control buttons and descriptions.

Control Buttons	Description
 Up	Use the Up navigation key to adjust (increase ranges) items in the OSD menu.
 Down	Use the Down navigation key to adjust (decrease ranges) items in the OSD menu.
 Left	For the first level in the Menu list, use the Left navigation key to exit/close the OSD menu.
 Right	For all other levels except the first level in the Menu list, the Right navigation key goes to the next level.
 OK	Press the joystick to confirm your selection.





NOTE: To exit the current menu item and return to the previous menu, move the joystick to the left until you exit.

Direct Key functions



Figure 34. Direct Key

Table 27. Control buttons and descriptions.

Control Buttons		Description
1	 Direct Key 1	Allows you to choose a feature from Off, Menu Launcher, Preset Modes, Brightness, Contrast, Input Source, Aspect Ratio, Volume, Audio Profiles, Smart HDR, Display Info, PIP/PBP Mode or Video Swap and set it as a Direct Key 1.
2	 Direct Key 2	Allows you to choose a feature from Off, Menu Launcher, Preset Modes, Brightness, Contrast, Input Source, Aspect Ratio, Volume, Audio Profiles, Smart HDR, Display Info, PIP/PBP Mode or Video Swap and set it as a Direct Key 2.
3	 Direct Key 3	Allows you to choose a feature from Off, Menu Launcher, Preset Modes, Brightness, Contrast, Input Source, Aspect Ratio, Volume, Audio Profiles, Smart HDR, Display Info, PIP/PBP Mode or Video Swap and set it as a Direct Key 3.
4	 Direct Key 4	Allows you to choose a feature from Off, Menu Launcher, Preset Modes, Brightness, Contrast, Input Source, Aspect Ratio, Volume, Audio Profiles, Smart HDR, Display Info, PIP/PBP Mode or Video Swap and set it as a Direct Key 4.
5	 Menu Launcher	To access the Menu Launcher.

Accessing the menu system

NOTE: After you change the settings, press the joystick to save the changes before exiting or proceeding to another menu.

1. Select the  icon to launch the OSD and display the main menu.

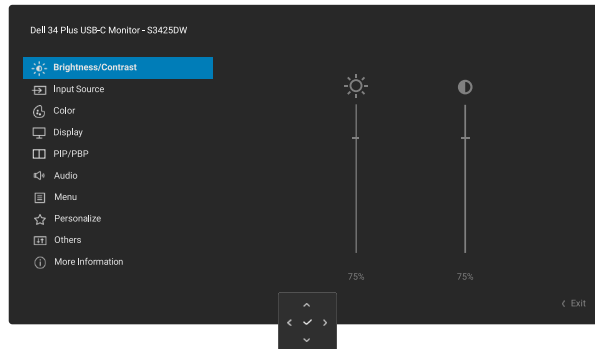



















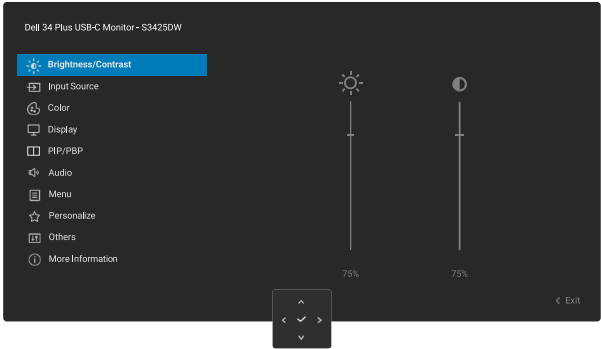

2. Press the joystick in  or  navigation key to activate the highlighted option.
 3. Press the  and  navigation key to move between the setting options. As you move from one icon to another, the option is highlighted.
 4. Press the  or  navigation key once to activate the highlighted option.
- NOTE:** The directional buttons (and the OK button) displayed may differ according to the menu you have selected. Use the available buttons to make your selection.
5. Press  and  navigation key to select the desired parameter.
 6. Press  and then use the  and  navigation key, according to the indicators on the menu, to make your changes.
 7. Select the  to return to the main menu.

Table 28. OSD menu

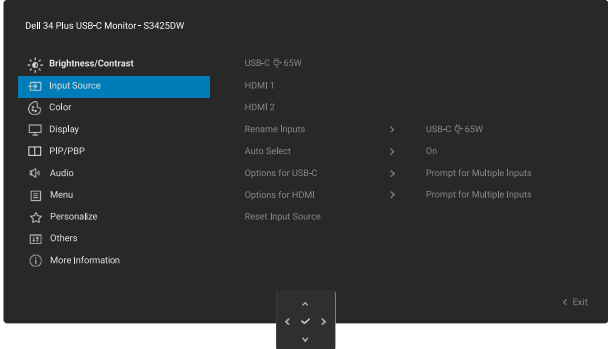
Icon	Menu and submenu	Description
	<p>Brightness/Contrast</p>	<p>Adjusts the brightness and the contrast of the display.</p> 
	<p>Brightness</p>	<p>Brightness adjusts the luminance of the backlight. Move the joystick up or down to increase or decrease the brightness level (min 0 ~ max 100).</p>
	<p>Contrast</p>	<p>Adjust Brightness first, and adjust Contrast only if you need further adjustment. The Contrast function adjusts the degree of difference between darkness and lightness on the monitor screen. Move the joystick up or down to increase or decrease the contrast level (min 0 ~ max 100).</p>

Icon	Menu and submenu	Description
	Input Source	Select between the different video signals that may be connected to your monitor. 
	USB-C  65W	Select USB-C  65W when you are using the USB-C upstream port. Press the joystick to confirm the selection.
	HDMI 1	Select HDMI 1 when you are using the HDMI port. Press the joystick to confirm the selection.
	HDMI 2	Select HDMI 2 when you are using the HDMI port. Press the joystick to confirm the selection.
	Rename Inputs	Allows you to specify a preset input name for the selected input source. The preset options are PC , PC 1 , PC 2 , Laptop , Laptop 1 , and Laptop 2 . By default, the setting is Off . <i>i</i> NOTE: When you perform a rename for the USB-C (65W) input, the wattage value remains after the specified option, for example, PC 1 (65W) . <i>i</i> NOTE: It is not applicable for the input names shown in the warning messages and Display Info .
	Auto Select	Automatically scans for available input sources. The default is On . Press the joystick to confirm the selection.
	Options for USB-C	Allows you to set Auto Select for USB-C to: <ul style="list-style-type: none"> • Prompt for Multiple Inputs: Always displays the Switch to USB-C Video Input message for you to choose whether to switch or not. • Always Switch: Automatically switches to USB-C video input (without prompting) when the USB-C cable is connected. • Off: Never switches to USB-C video input when the USB-C cable is connected. Press the joystick to confirm the selection. <i>i</i> NOTE: This function is not available when Auto Select is set to Off .
	Options for HDMI	Allows you to set the function to: <ul style="list-style-type: none"> • Prompt for Multiple Inputs: Always displays the Switch to HDMI Video Input message for you to choose whether to switch or not. • Always Switch: Automatically switches to HDMI video input (without prompting) when the USB-C or HDMI cable is connected. • Off: Never switches to HDMI video input when the HDMI cable is connected. Press the joystick to confirm the selection. <i>i</i> NOTE: This function is not available when Auto Select is set to Off .
Reset Input Source	Resets Input Source to the default settings.	

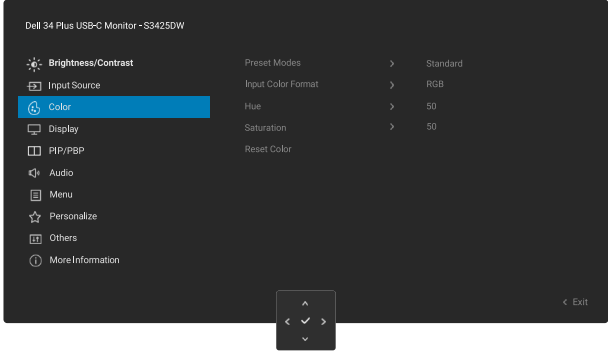

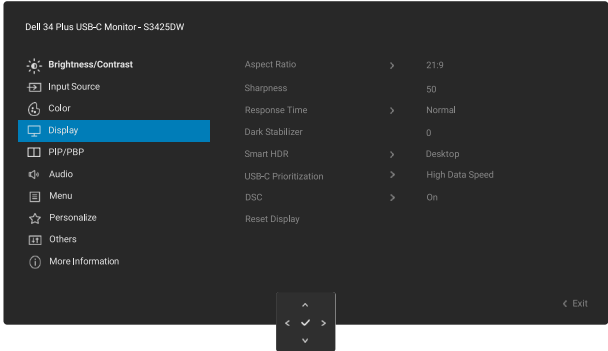

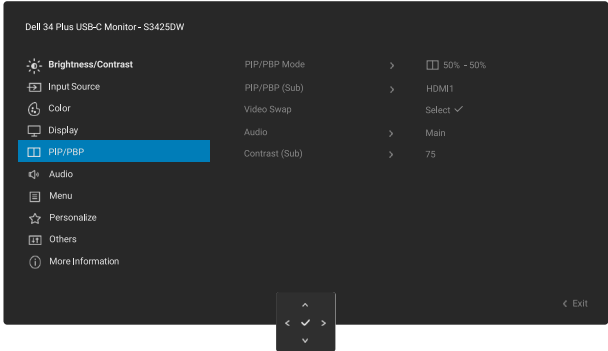
Icon	Menu and submenu	Description
	Color	Adjusts the color setting mode. 
	Preset Modes	Allows you to choose from the list of preset color modes. Press the joystick to confirm the selection. <ul style="list-style-type: none"> • Standard: This is the default setting. Using a low blue light panel, this monitor is certified by TÜV to reduce blue light output and create more relaxing and less stimulating images. • Movie: Loads color settings ideal for movies. • FPS: Loads color settings ideal for First-Person Shooter games. • RTS: Loads color settings ideal for Real-time Strategy games. • RPG: Loads color settings ideal for Role-Playing games. • Warm: Presents colors at lower color temperatures. The screen appears warmer with a red/yellow tint. • Cool: Presents colors at higher color temperatures. The screen appears cooler with a blue tint. • sRGB: Presents colors at sRGB color space. • Custom Color: Allows you to manually adjust the color settings (R/G/B) and create your own preset color mode.
	Input Color Format	Allows you to set the video input mode to: <ul style="list-style-type: none"> • RGB: Select this option if your monitor is connected to a computer or a media player that supports RGB output. • YCbCr: Select this option if your media player supports only YCbCr output.
	Hue	This function can shift the color of the video image to green or purple. This is used to adjust the desired flesh tone color. Move the joystick to adjust the hue level from 0 to 100. <i>i</i> NOTE: The function is available only when you select Movie, FPS, RTS, or RPG mode.
	Saturation	This function can adjust the color saturation of the video image. Move the joystick to adjust the saturation level from 0 to 100. <i>i</i> NOTE: The function is available only when you select Movie, FPS, RTS, or RPG mode.
	Reset Color	Resets Color to the default settings.

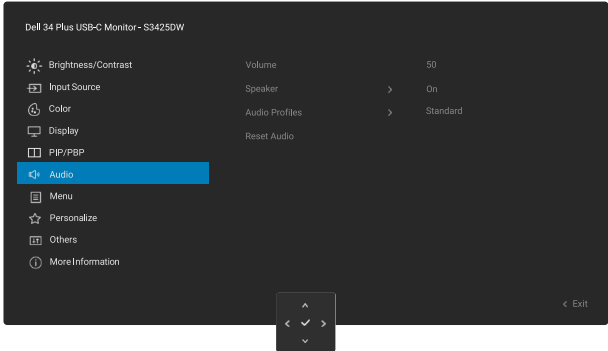
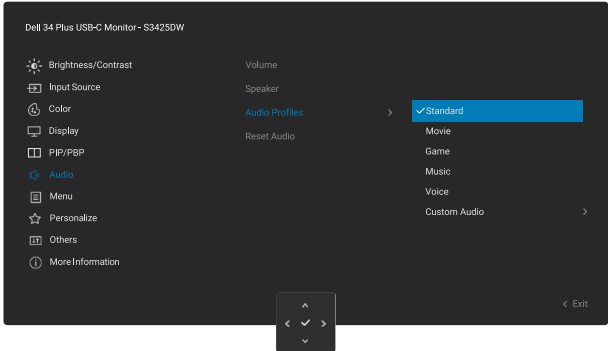
Icon	Menu and submenu	Description
	Display	Use Display to adjust the image. 
	Aspect Ratio	Adjusts the image ratio to 21:9, Auto Resize, 4:3 or 1:1 .
	Sharpness	Adjusts the picture sharpness of the display. Move the joystick to adjust the sharpness level from 0 to 100.
	Response Time	Allows you to set the response time to Normal, Fast, or Extreme .
	Dark Stabilizer	The feature improves the visibility in the dark gaming scenarios. The higher the value (between 0 to 3), the better visibility in the dark area of the display image. The default setting is 0 .
	Smart HDR	The Smart HDR (High Dynamic Range) feature enhances the display output by optimally adjusting contrast and the ranges of color and luminosity to resemble true-to-life visuals. <ul style="list-style-type: none"> • Desktop: Suitable for using the monitor with a desktop computer. • Movie HDR: Suitable for the playback of HDR video content. • Game HDR: Suitable for playing HDR-compatible games. It displays more realistic scenes and makes the gaming experience immersive and entertaining. • Off: Disables Smart HDR. <p>NOTE: When activating and deactivating Smart HDR, a blank screen is expected (about 5 seconds). This is normal behavior as the monitor changes the display mode. Do not power cycle the monitor.</p> <p>NOTE: When the monitor is processing HDR content, Preset Modes, Dark Stabilizer, Brightness, and Contrast are disabled.</p>
	USB-C Prioritization	Allows you to specify the priority to transfer the data with high resolution (High Resolution) or high speed (High Data Speed) when using the USB-C devices. If the current platform is DP 1.4 (HBR3), use High Data Speed to access video performance with high data speed. If the current platform is DP 1.2 (HBR2) or below, select High Resolution for accessing full video performance with data speed drop.
	DSC	Supports NVIDIA DSR/DLDSR feature which requires the DSC to be Off . <p>NOTE: This function is only available with a USB-C input source. The maximum resolution and refresh rate will be lower when DSC is Off, See Video bandwidth for further details.</p>
	Reset Display	Resets Display to the default settings.

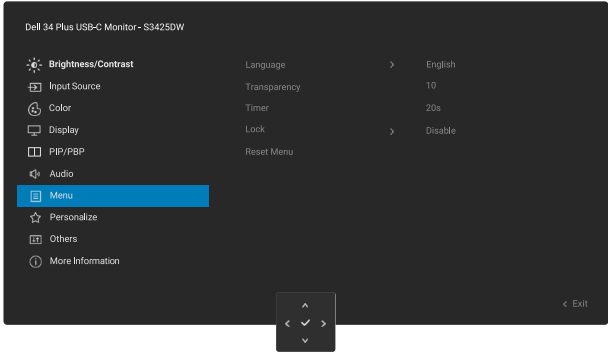
Icon	Menu and submenu	Description
	<p>PIP/PBP</p>	<p>Allows you to watch more images at the same time.</p> 
	<p>PIP/PBP Mode</p>	<p>Adjusts the PIP/PBP Mode. You can adjust this feature by selecting Off, 50%-50%, 75%-25%, 25%-75%, 67%-33%, 33%-67%, PIP (Small), PIP (Large).</p> <p>NOTE: FreeSync is not supported when PIP/PBP is enabled. NOTE: HDR is not supported when PIP/PBP is enabled. NOTE: DSC is not supported when PIP/PBP is enabled.</p>
	<p>PIP/PBP (Sub)</p>	<p>Allows you to select between USB-C, HDMI 1, or HDMI 2 video signal that may be connected to your monitor for the PIP/PBP sub-window.</p>
	<p>Video Swap</p>	<p>Allows you to swap videos between the main window and sub-window in PIP/PBP Mode.</p>
	<p>Audio</p>	<p>Allows you to set the Audio Main or Sub.</p>
	<p>Contrast (Sub)</p>	<p>Adjusts the contrast level of the picture in PIP/PBP Mode.</p> <p>NOTE: This feature is applicable only when the user turns on PIP/PBP.</p>

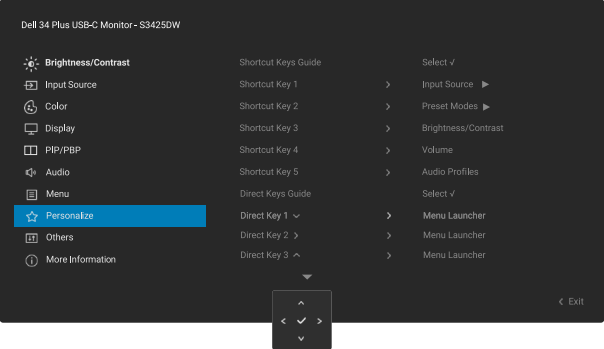
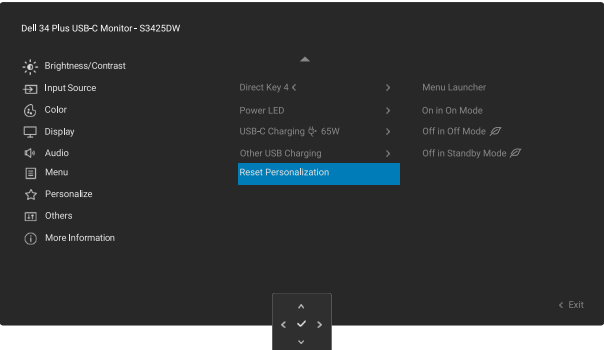
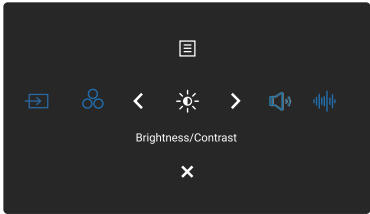
Icon	Menu and submenu	Description
	Audio	Adjusts the audio settings. 
	Volume	Use the buttons to adjust the volume. Minimum is 0 (-). Maximum is 100 (+).
	Speaker	Allows you to turn on or off the speaker.
	Audio Profiles	Expand to show the various audio profiles.  <ul style="list-style-type: none"> • Standard: Default audio setting. • Movie: For motion picture viewing. • Game: For game. • Music: For music listening. • Voice: For speech. • Custom Audio: Allows you to manually adjust the sound. Move the joystick < and > to adjust the setting.
	Reset Audio	Resets Audio to the default settings.

Icon	Menu and submenu	Description
	Menu	Adjusts the settings of the OSD, such as the languages of the OSD, the amount of time the menu remains on screen, and so on. <div data-bbox="711 293 1321 645" style="text-align: center;">  </div>
	Language	Sets the OSD display to one of the eight languages (English, Spanish, French, German, Brazilian Portuguese, Russian, Simplified Chinese, or Japanese).
	Transparency	Select to change the menu transparency by moving the joystick (min. 0/max. 100).
	Timer	Sets the length of time for the OSD to remain active after your last operation with the joystick. Move the joystick to adjust the slider in 1 second increments, from 5 to 60 seconds.
	Lock	Controls user access to adjustments. User can select one of the following: Menu Buttons , Power Button , Menu + Power Buttons , or Disable .
	Reset Menu	Resets Menu to the default settings.

Icon	Menu and submenu	Description
	Personalize	<p>Select this option to adjust the settings of the personalization.</p>  
	Shortcut Keys Guide	Select this option for entering Shortcut Keys Guide .
	Shortcut Key 1	Select a function from Preset Modes, Brightness/Contrast, Input Source, Aspect Ratio, Volume, Audio Profiles, Smart HDR, Display Info, PIP/PBP Mode or Video Swap and set it as a shortcut key in the menu launcher.
	Shortcut Key 2	
	Shortcut Key 3	
	Shortcut Key 4	
	Shortcut Key 5	
		
	Direct Keys Guide	Select this option for entering Direct Keys Guide .
	Direct Key 1	Allows you to choose a feature from Off, Menu Launcher, Preset Modes, Brightness, Contrast, Input Source, Aspect Ratio, Volume, Audio Profiles, Smart HDR, Display Info, PIP/PBP Mode or Video Swap and set it as a Direct Key .
	Direct Key 2	
	Direct Key 3	
	Direct Key 4	
	Power LED	Allows you to set the state of the power light to save energy.
USB-C Charging  65W	Allows you to enable or disable the USB-C Charging  65W function during monitor off mode. If On in Off Mode is selected, you can charge your laptop or mobile devices through the USB-C cable even when the monitor is powered Off.	
Other USB Charging	<p>Allows you to enable or disable the USB Type-A and USB-C downstream Ports charging function when the monitor is in standby mode.</p> <p>When this function is enabled, you can charge your mobile devices even when the monitor is in standby mode.</p> <p> NOTE: This function is available when the USB-C cable is unplugged from the upstream port. If the USB-C cable is connected, Other USB Charging follows the USB host power status and the function is not accessible.</p>	
Reset Personalization	Resets Personalize to the default settings.	

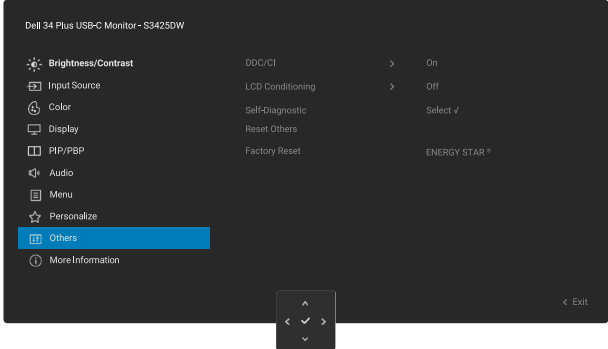
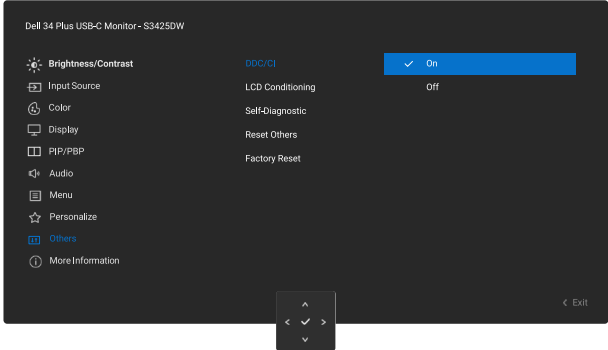
Icon	Menu and submenu	Description
	<p>Others</p>	<p>Adjusts the OSD settings, such as DDC/CI, LCD Conditioning, Self-Diagnostic, Reset Others, and Factory Reset.</p> 
	<p>DDC/CI</p>	<p>DDC/CI (Display Data Channel/Command Interface) allows you to adjust the monitor settings using software on your computer. Enable this function for the best user experience and optimum performance of your monitor. You can disable this function by selecting Off.</p> 

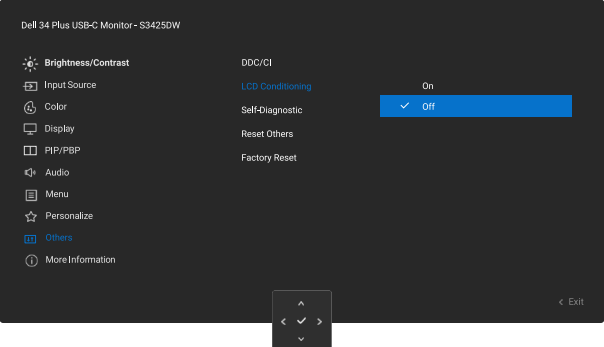
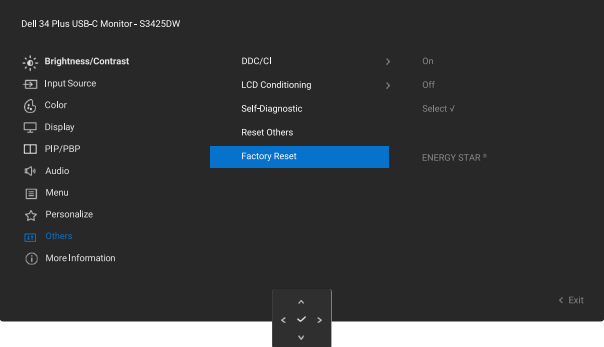
Icon	Menu and submenu	Description
	LCD Conditioning	<p>Helps reduce minor cases of image retention. Depending on the degree of image retention, the program may take some time to run. By default, the setting is Off. You can enable this function by selecting On.</p>  <p>The screenshot shows the OSD menu for a Dell 34 Plus USB-C Monitor - S3425DW. The 'LCD Conditioning' option is highlighted in blue and set to 'Off'. Other menu items include Brightness/Contrast, Input Source, Color, Display, PIP/PBP, Audio, Menu, Personalize, Others, and More Information. A directional pad is visible at the bottom center.</p>
	Self-Diagnostic	Select this function to run the built-in diagnostics, see Built-in diagnostics .
	Reset Others	Resets all settings under the Others menu to the factory preset values.
	Factory Reset	<p>Restores all preset values to the factory default settings. These are also the settings for ENERGY STAR tests.</p>  <p>The screenshot shows the OSD menu for a Dell 34 Plus USB-C Monitor - S3425DW. The 'Factory Reset' option is highlighted in blue. Other menu items include Brightness/Contrast, Input Source, Color, Display, PIP/PBP, Audio, Menu, Personalize, Others, and More Information. A directional pad is visible at the bottom center.</p>

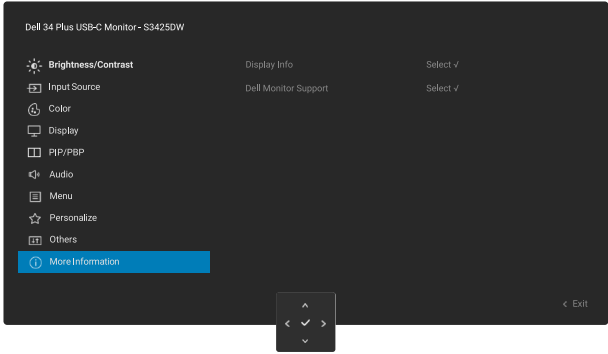
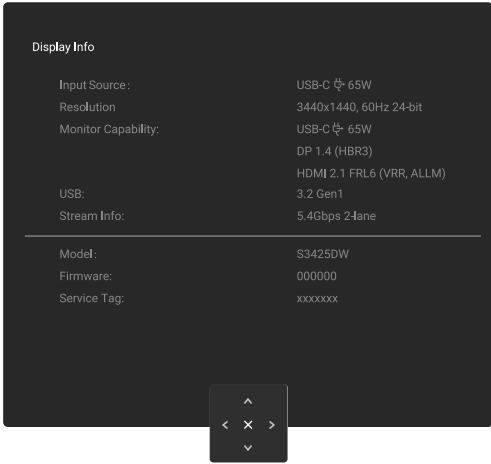
Icon	Menu and submenu	Description
	More Information	<p>Allows you to view the monitor's information or seek more monitor support.</p> 
	Display Info	<p>Displays current settings, firmware version, and Service Tag of your monitor.</p>  <p>NOTE: The image shown is for the purpose of illustration only. The information may vary depending on the model and current settings.</p>
	Dell Monitor Support	<p>To access the general monitor support materials for your monitor, use your smartphone to scan the QR code.</p>

OSD messages

Initial Setup

When you turn on the monitor, the following message appears:



Figure 35. The message of pressing the joystick

If you press the joystick, the following message appears:

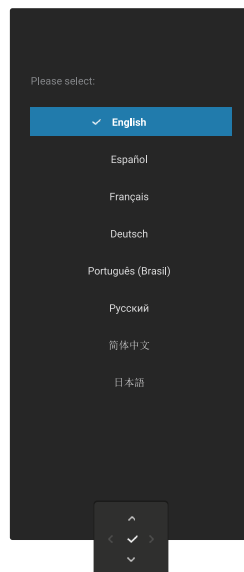

Figure 36. The message of selecting language

If you select your language, the following message appears:

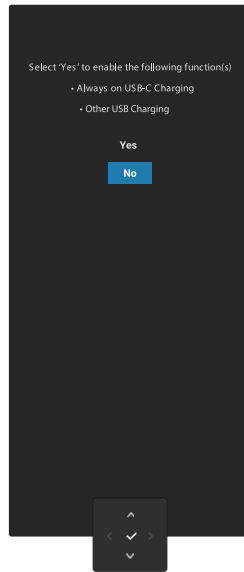

Figure 37. The message of selecting the USB charging function

If you select this function or message timeout, the following message appears:

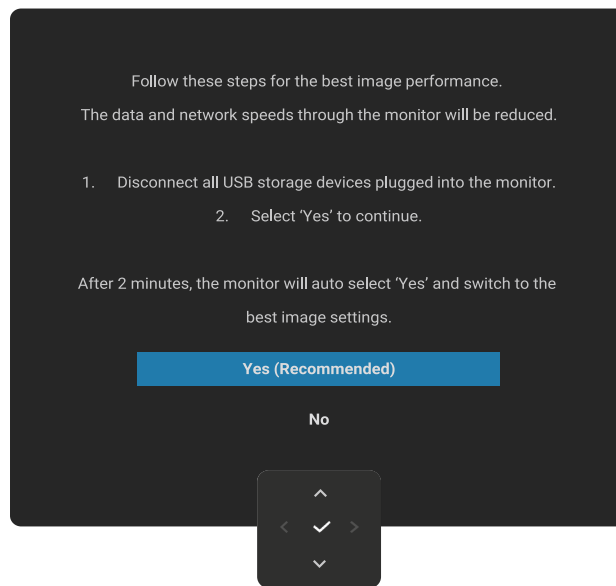

Figure 38. The message of selecting the USB charging function or message timeout

OSD warning message

When the monitor does not support a particular resolution mode, the following message appears:

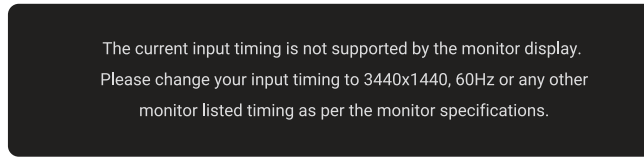

Figure 39. Warning message of not supported resolution mode

This means that the monitor cannot synchronize with the signal that it is receiving from the computer. See [Monitor specifications](#) for the Horizontal and Vertical frequency ranges addressable by this monitor.

NOTE: The recommended mode is **3440 x 1440**.

When you adjust the **Brightness** level above the default level for the first time, the following message appears:

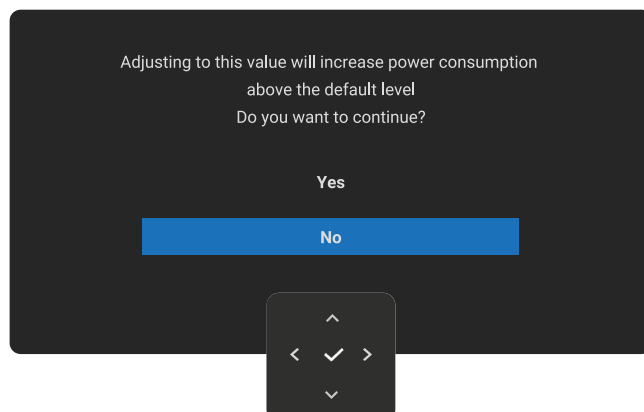

Figure 40. Warning message of adjusting the Brightness

NOTE: If you select **Yes**, the message does not appear the next time you change the **Brightness** setting.

You will see the following message before the **Lock** function is activated:

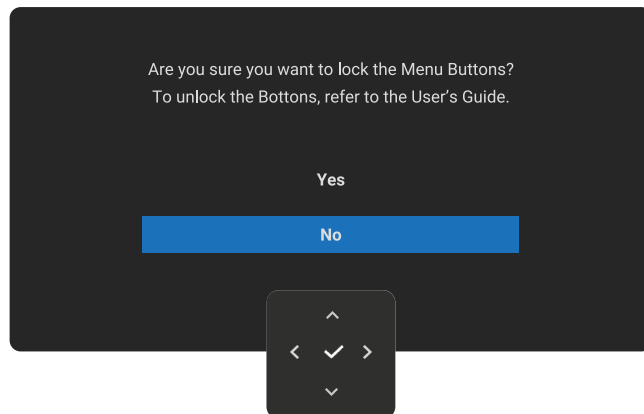

Figure 41. Warning message of activating the Lock function

NOTE: The message may slightly vary according to the selected settings.

You will see the following message before the **DDC/CI** function is disabled:

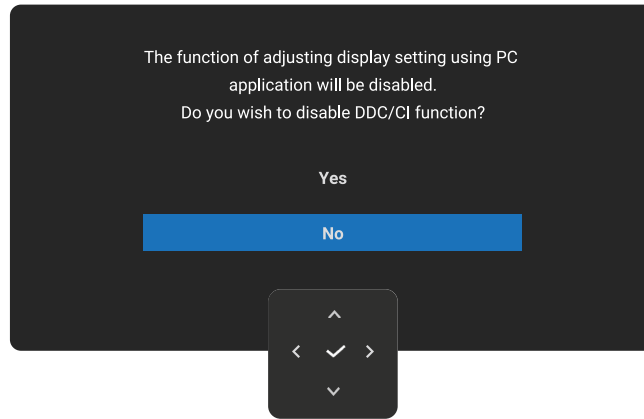

Figure 42. Warning message of the DDC/CI

When the monitor goes into Standby mode, the following message appears:

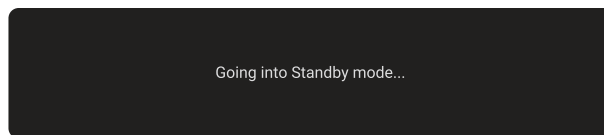

Figure 43. The message of the Standby Mode

Activate the computer and wake up the monitor to gain access to the OSD.

The OSD functions only in the normal operation mode. If you press the joystick during the Standby mode, the following message appears depending on the selected input:

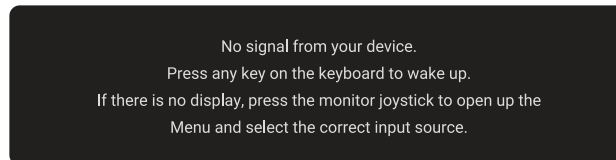

Figure 44. Warning message of No signal input

Activate the computer and the monitor to gain access to the OSD.

i NOTE: The message may slightly vary according to the connected input signal.

If HDMI 1, HDMI 2, or USB-C input is selected and the corresponding cable is not connected, the following message appears:

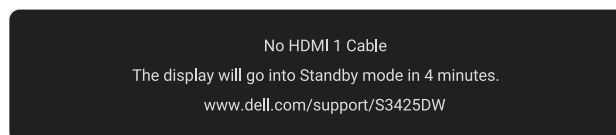

Figure 45. The message of No HDMI 1 cable

or

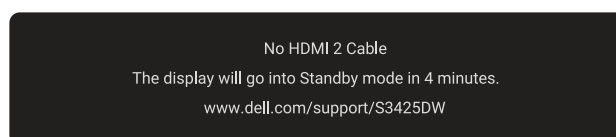

Figure 46. The message of No HDMI 2 cable

or

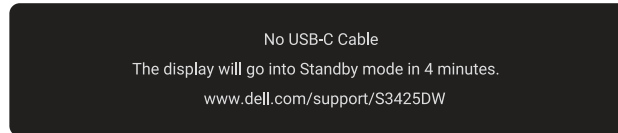

Figure 47. The message of No USB-C cable

NOTE: The message may slightly vary according to the selected input signal.

See [Troubleshooting](#) for more information.

Locking the control buttons

You can lock the monitor control buttons to prevent access to the OSD menu and/or power button.

1. Move and hold the joystick up, down, left, or right for about four seconds until a pop-up menu appears.

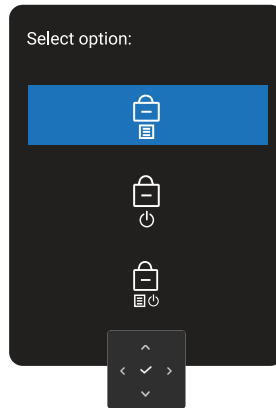

Figure 48. The message of locking the control buttons

2. Move the joystick to select one of the following options:



: The OSD menu settings are locked and not accessible.



: The power button is locked.



: The OSD menu settings are not accessible and the power button is locked.

3. Press the joystick to confirm the configuration.

To unlock, move and hold the joystick up or down or left or right for about four seconds until a menu appears, and then select  to unlock and close the pop-up menu.

Setting the maximum resolution

NOTE: The steps may vary slightly depending on the version of Windows you have.

To set the maximum resolution for the monitor:

In Windows 10 and Windows 11:

1. Right-click on the desktop and click **Display settings**.
2. If you have more than one monitor connected, ensure to select **S3425DW**.
3. Click the **Display Resolution** drop-down list and select **3440 x 1440**.
4. Click **Keep changes**.

If you do not see **3440 x 1440** as an option, you must update your graphics driver to the latest version.

Depending on your computer, complete one of the following procedures:

If you have a Dell desktop or laptop:

- Go to [Dell Support Site](#), enter your Service Tag, and download the latest driver for your graphics card.

If you are using a non-Dell computer (laptop or desktop):

- Go to the support site for your non-Dell computer and download the latest graphic card drivers.
- Go to the graphics card's website and download the latest graphic card drivers.

Troubleshooting

⚠ WARNING: Before you begin any of the procedures in this section, follow the [Safety instructions](#).

Self-Test

Your monitor provides a self-test feature that allows you to check whether your monitor is functioning properly. If your monitor and computer are properly connected but the monitor screen remains dark, run the monitor self-test by performing the following steps:

1. Turn off both your computer and the monitor.
2. Unplug the video cable from the computer.
3. Turn on the monitor.

If the monitor cannot sense a video signal and is working correctly, the following message appears:

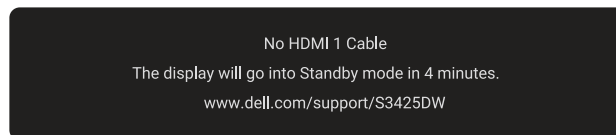

Figure 49. The message of no HDMI 1 cable

or

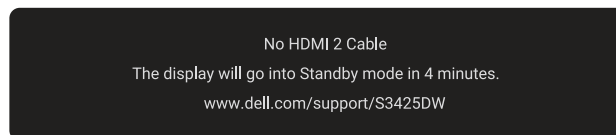

Figure 50. The message of no HDMI 2 cable

or

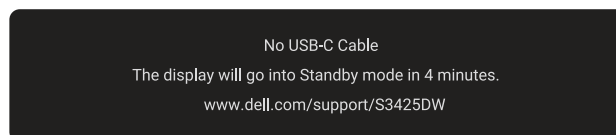

Figure 51. The message of no USB-C cable

ⓘ NOTE: The message may slightly vary according to the connected input signal.

ⓘ NOTE: While in self-test mode, the power LED remains white.

4. This message can also appear during normal system operation if the video cable gets disconnected or damaged.
5. Turn off your monitor, reconnect the video cable, and then turn on both the computer and the monitor.

If your monitor screen remains blank after performing the above steps, it indicates the monitor is functioning properly. Check the video controller and computer.

Built-in diagnostics

Your monitor includes a built-in diagnostic tool to help you identify whether the screen abnormality is due to an issue with the monitor itself or with your computer and video card.

To run the built-in diagnostics:

1. Ensure that the screen is clean (no dust particles on the surface of the screen).
2. Press the joystick button to launch the OSD Main Menu.
3. Move the joystick button to select **Others > Self-Diagnostic** to initiate the self-diagnostic process.

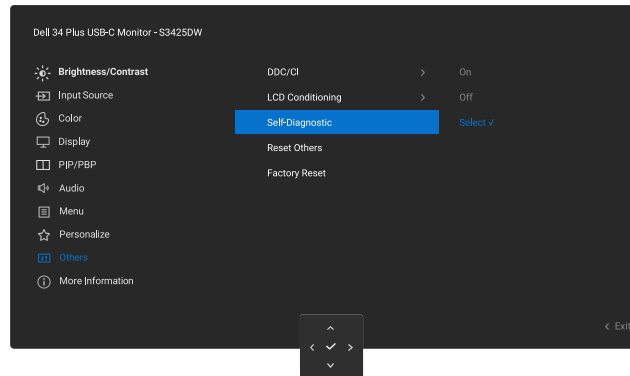

Figure 52. Built-in diagnostics

4. When initiated, a gray screen appears. Inspect the screen for abnormalities.
5. Switch the joystick button. The color of the screen changes to red. Inspect the screen for abnormalities.
6. Repeat step 5 and inspect the screen when it displays the colors green, blue, black, and white followed by the on-screen text.
7. The test is complete when the text screen appears. To exit, toggle the joystick button again.

If you do not detect any screen abnormalities upon using the Built-in diagnostics tool, the monitor is functioning properly. Check the video card and computer.

Common problems



The following table contains general information about common monitor problems that you might encounter and the possible solutions:

Table 29. Common problems

Common symptoms	What you experience	Possible solutions
No video/power LED off	No picture	<p>Ensure that the video cable connecting the monitor and the computer is properly connected and secure.</p> <p>Verify that the power outlet is functioning properly using any other electrical equipment.</p> <p>Ensure that the power button is pressed fully.</p> <p>Ensure that the correct input source is selected in the Input Source menu.</p>
No video/power LED on	No picture	<p>Increase brightness and contrast controls using the OSD.</p> <p>Perform monitor self-test feature check.</p> <p>Check for bent or broken pins in the video cable connector.</p> <p>Run the built-in diagnostics. For more information, see Built-in diagnostics.</p> <p>Ensure that the correct input source is selected in the Input Source menu.</p>
Poor focus	Picture is fuzzy, blurry, or ghosting	<p>Eliminate video extension cables.</p> <p>Reset the monitor to factory settings (Factory Reset).</p> <p>Change the video resolution to the correct aspect ratio.</p>
Shaky/jittery video	Wavy picture or fine movement	<p>Reset the monitor to factory settings (Factory Reset).</p> <p>Check environmental factors.</p> <p>Relocate the monitor and test in another room.</p>
Missing pixels	LCD screen has spots	<p>Cycle power On-Off.</p> <p>Pixel that is permanently off is a natural defect that can occur in LCD technology.</p> <p>For more information about Dell Monitor Quality and Pixel Policy, see www.dell.com/pixelguidelines.</p>
Stuck-on pixels	LCD screen has bright spots	<p>Cycle power On-Off.</p> <p>Pixel that is permanently off is a natural defect that can occur in LCD technology.</p> <p>For more information about Dell Monitor Quality and Pixel Policy, see www.dell.com/pixelguidelines.</p>
Geometric distortion	Screen not centered correctly	<p>Reset the monitor to factory settings (Factory Reset).</p>
Horizontal or vertical lines	Screen has one or more lines	<p>Reset the monitor to factory settings (Factory Reset).</p> <p>Perform a monitor self-test feature check (see Self-Test) and determine if these lines are also in self-test mode.</p> <p>Check for bent or broken pins in the video cable connector.</p> <p>Run the built-in diagnostics. For more information, see Built-in diagnostics.</p>
Synchronization problems	Screen is scrambled or appears torn	<p>Reset the monitor to factory settings (Factory Reset).</p> <p>Perform monitor self-test feature check (see Self-Test) to determine if the scrambled screen appears in self-test mode.</p> <p>Check for bent or broken pins in the video cable connector.</p> <p>Restart the computer in the safe mode.</p>

Common symptoms	What you experience	Possible solutions
Safety-related issues	Visible signs of smoke or sparks	Do not perform any troubleshooting steps. Contacting Dell immediately.
Intermittent problems	Monitor malfunctions on and off	Ensure that the video cable connecting the monitor to the computer is connected properly and is secure. Reset the monitor to factory settings (Factory Reset). Perform monitor self-test feature check (see Self-Test) to determine if the scrambled screen appears in self-test mode.
Missing color	Picture is missing color	Perform monitor self-test feature check (see Self-Test). Ensure that the video cable connecting the monitor to the computer is connected properly and is secure. Check for bent or broken pins in the video cable connector.
Wrong color	Picture color is not good	Change the settings of the Preset Modes in the Color menu OSD depending on the application. Adjust the R/G/B values under Custom Color in the Color menu OSD. Change the Input Color Format to RGB or YCbCr in the Color settings OSD. Run the built-in diagnostics. For more information, see Built-in diagnostics .
Image retention from a static image left on the monitor for a long period of time	A faint shadow from the static image displayed appears on the screen	Set the screen to turn off after a few minutes of screen idle time. These can be adjusted in the Windows Power Options or Mac Energy Saver setting. Alternatively, use a dynamically changing screensaver.
Video ghosting or overshooting	Video ghosting, shadows, or color smear while scrolling	Change the Response Time in the Display menu OSD to Normal .
Screen image is too small	The image is centered on the screen, but does not fill the entire viewing area	Check the Aspect Ratio setting in the Display menu OSD. Reset the monitor to factory settings (Factory Reset).
Cannot adjust the monitor with the joystick	OSD does not appear on the screen	Turn off the monitor, unplug the power cable, plug it back, and then turn on the monitor. Check whether the OSD menu is locked. If yes, move and hold the joystick up/down/left/right for 4 seconds to unlock (see Lock and Locking the control buttons).
No input signal when you press the power button or move the joystick	No picture, the LED light is white	Check the signal source. Ensure the computer is not in the power-saving mode by moving the mouse or pressing any key on the keyboard. Check whether the signal cable is plugged in properly. Re-plug the signal cable if necessary. Reset the computer or video player.
The picture does not fill the entire screen	The picture cannot fill the height or width of the screen	Due to different video formats (aspect ratio) of DVDs, the monitor may display in full screen. Run the built-in diagnostics. For more information, see Built-in diagnostics .
No video at HDMI port/USB-C port	When connected to some dongle/docking device at the port, there is no video when unplugging/plugging the cable from the laptop	Unplug the HDMI/USB-C cable from the dongle/docking device, then plug the HDMI/USB-C cable directly into the laptop.

Universal Serial Bus (USB) specific problems

Common symptoms	What you experience	Possible solutions
USB interface is not working	USB peripherals are not working	<ul style="list-style-type: none"> • Check that your monitor is turned on. • Reconnect the upstream cable to your computer. • Reconnect the USB peripherals (downstream port). • Turn the monitor off and then back on again. • Reboot the computer. • Some USB devices like external portable hard drive require higher electric current; connect the device directly to the computer system.
USB-C port with  icon on the rear side of the monitor does not supply power	USB peripherals cannot be charged	<ul style="list-style-type: none"> • Check that the connected device is compliant with the USB-C specification. The USB-C port (video and data) with  icon supports USB 5Gbps and an output of 65 W. • Check that you use the USB-C cable shipped with your monitor.
USB 5Gbps interface is slow	USB 5Gbps peripherals working slowly or not working at all	<ul style="list-style-type: none"> • Check that your computer is USB 5Gbps - compatible. • Some computers have USB 3.2, USB 2.0, and USB 1.1 ports. Ensure that the correct USB port is used. • Reconnect the upstream cable to your computer. • Reconnect the USB peripherals (downstream port). • Reboot the computer.
Wireless USB peripherals stop working when a USB 3.2 device is plugged in	Wireless USB peripherals responding slowly or only working as the distance between itself and its receiver decreases	<ul style="list-style-type: none"> • Increase the distance between the USB 3.2 peripherals and the wireless USB receiver. • Position your wireless USB receiver as close as possible to the wireless USB peripherals. • Use a USB-extender cable to position the wireless USB receiver as far away as possible from the USB 3.2 port.
Wireless USB mouse does not work properly	When connected to a USB port on the Quick Access panel at the bottom of the monitor, the wireless USB mouse stops responding (or becomes unresponsive) during use.	<ul style="list-style-type: none"> • Unplug the wireless USB mouse receiver and re-plug it into the rear side USB port of the monitor.

Regulatory information

FCC notices (U.S. Only) and other regulatory information

For FCC notices and other regulatory information, see the regulatory compliance website at www.dell.com/regulatory_compliance.

EU product database for energy label and product information sheet

S3425DW: <https://eprel.ec.europa.eu/qr/2198463>

Contacting Dell

To contact Dell for sales, technical support, or customer service issues, see www.dell.com/contactdell.

- ① **NOTE:** Availability varies by country, region, or product, and some services may not be available in your country.
- ① **NOTE:** If you do not have an active Internet connection, you can find contact information about your purchase invoice, packing slip, bill, or Dell product catalog.