

# User Guide



Lenovo

IdeaCentre AIO i (24", 11) and IdeaCentre AIO i (27", 11)

## About this documentation

This documentation applies to the Lenovo product models listed below.

Model name	Machine types (MT)
IdeaCentre AIO 24ILL11	F0JX, F0JY
IdeaCentre AIO 27ILL11	F0JV, F0JW

Before using this documentation and the product it supports, ensure that you read and understand the following:

- *Safety and Warranty Guide*
- *Generic Safety and Compliance Notices*
  - For computers purchased in mainland China: [https://iknow.lenovo.com.cn/detail/dc\\_191404.html](https://iknow.lenovo.com.cn/detail/dc_191404.html)
  - For computers purchased outside mainland China: [https://pcsupport.lenovo.com/docs/generic\\_notices](https://pcsupport.lenovo.com/docs/generic_notices)
- *Setup Guide (if provided with your computer)*

### Notes:

- Illustrations in this documentation may look slightly different from your product model.
- For more compliance information, refer to:
  - For computers purchased in mainland China  
*Generic Safety and Compliance Notices* at [https://iknow.lenovo.com.cn/detail/dc\\_191404.html](https://iknow.lenovo.com.cn/detail/dc_191404.html)
  - For computers purchased outside mainland China  
*Regulatory Notice* at [https://support.lenovo.com/docs/common\\_commercial\\_rnhttps://support.lenovo.com/docs/common\\_consumer\\_dt\\_rn](https://support.lenovo.com/docs/common_commercial_rnhttps://support.lenovo.com/docs/common_consumer_dt_rn) and *Generic Safety and Compliance Notices* at <https://www.lenovo.com/compliance>
- Depending on the model, some optional accessories, features, and software programs might not be available on your computer.
- Depending on the version of the operating systems and programs, some user interface instructions might not be applicable to your computer.
- Documentation content is subject to change without notice. Lenovo makes constant improvements to the documentation of your computer, including this *User Guide*. To get the latest documentation, go to:
  - For computers purchased in mainland China: <https://newsupport.lenovo.com.cn>
  - For computers purchased outside mainland China: <https://pcsupport.lenovo.com>
- Microsoft® makes periodic feature changes to the Windows® operating system through Windows Update. As a result, some information in this documentation might become outdated. Refer to Microsoft resources for the latest information.

### First Edition (January 2026)

#### © Copyright Lenovo 2026.

LIMITED AND RESTRICTED RIGHTS NOTICE: If data or software is delivered pursuant to a General Services Administration "GSA" contract, use, reproduction, or disclosure is subject to restrictions set forth in Contract No. GS-35F-05925.

---

# Contents

## **Chapter 1. Meet your computer . . . . . 1**

Overview . . . . .	1
Rear . . . . .	2
Specifications . . . . .	3
USB specifications . . . . .	4
The Vantage app . . . . .	4

## **Chapter 2. Get started with your computer . . . . . 6**

Carry the computer . . . . .	6
Set up the computer . . . . .	6
Adjust the computer stand . . . . .	7
Shut down the computer . . . . .	8
Change display settings . . . . .	8
Use the touch screen (for selected models) . . . . .	8
Connect to a Bluetooth device . . . . .	11
Conventional pair . . . . .	11
Swift pair . . . . .	11
Set the power plan . . . . .	11
Security . . . . .	12
Use software security solutions . . . . .	12

## **Chapter 3. CRU replacement . . . . . 13**

What is CRU . . . . .	13
-----------------------	----

CRU list . . . . .	13
Power cord and ac power adapter . . . . .	13

## **Chapter 4. Help and support . . . . . 15**

Find your serial number. . . . .	15
Diagnose and troubleshoot your computer . . . . .	15
Troubleshoot and diagnose at Lenovo	
Support Web site . . . . .	15
Hardware scan . . . . .	16
Recover your Windows operating system. . . . .	16
Call Lenovo . . . . .	17
Before you contact Lenovo . . . . .	17
Self-help resources . . . . .	17
Purchase accessories or additional services . . . . .	18
Accessibility features. . . . .	18

## **Appendix A. Supplementary information . . . . . 19**

## **Appendix B. Important notice for Quebec consumers . . . . . 20**

## **Appendix C. Notices and trademarks. . . . . 21**

# Chapter 1. Meet your computer

## Overview

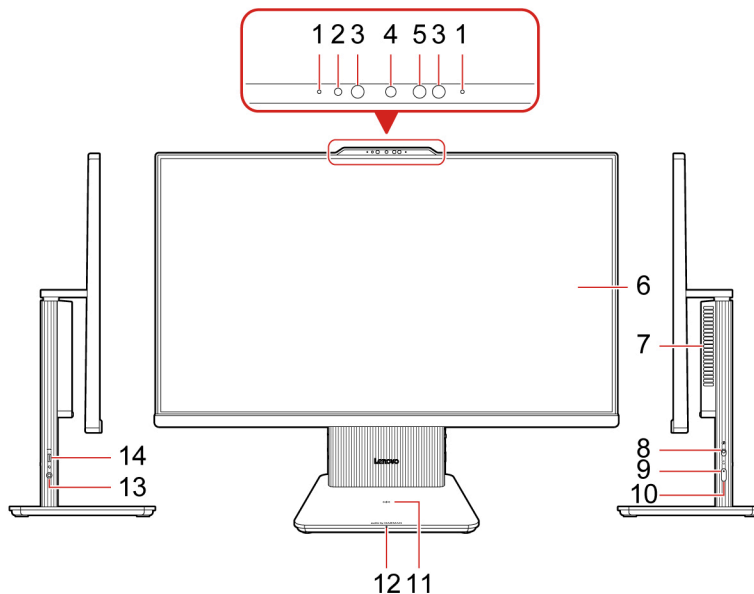

Item	Description	Item	Description
1	Microphones	2	Integrated camera activity indicator
3	Infrared LED*	4	Integrated camera
5	Infrared camera*	6	Multi-touch screen*
7	Air vent	8	Camera switch
9	Power button indicator	10	Power button
11	Wireless charging pad*	12	Wireless charging indicator*
13	Combo audio jack	14	USB-C® connector (USB 10Gbps)

\* for selected models

### Notes:

- Place the phone horizontally on the center of the wireless charging pad to activate wireless charging.
- For more information about the USB connector name update, see Appendix A “Supplementary information” on page 19.

### Statement on USB transfer rate

Depending on many factors such as the processing capability of the host and peripheral devices, file attributes, and other factors related to system configuration and operating environments, the actual transfer rate using the various USB connectors on this device will vary and will be slower than the data rate listed in the connector name or below for each corresponding device.

USB device	Data rate (Gbit/s)
Thunderbolt 3	40
Thunderbolt 4	40

### Power indicator

Show the system status of your computer.

- **On:** The computer is on.
- **Off:** The computer is off or in hibernation mode.
- **Blinking slowly:** The computer is in sleep mode.

### Related topics

- “USB specifications” on page 4
- “Use the touch screen (for selected models)” on page 8

## Rear

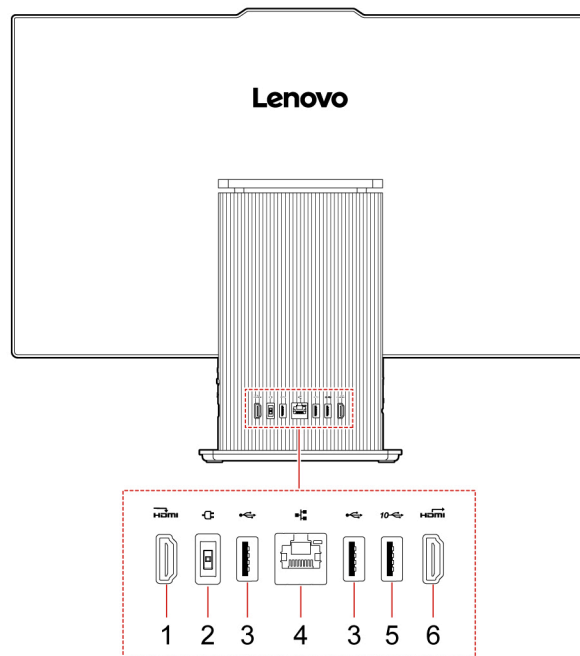

Item	Description	Item	Description
1	HDMI™ in connector	2	Power connector
3	USB-A connector (Hi-Speed USB)	4	Ethernet connector
5	USB-A connector (USB 10Gbps)	6	HDMI 2.1 TMDS out connector

### Related topic

“USB specifications” on page 4

---

## Specifications

---

Specification	Description
<b>Hardware configuration</b>	Type <b>Device Manager</b> in the Windows search box and then press Enter. Type the administrator password or provide confirmation, if prompted.
<b>Power supply</b>	<ul style="list-style-type: none"><li>• 90-watt automatic voltage-sensing power supply*</li><li>• 135-watt automatic voltage-sensing power supply*</li></ul>
<b>Electrical input</b>	<ul style="list-style-type: none"><li>• Input voltage: From 100 V ac to 240 V ac</li><li>• Input frequency: 50/60 Hz</li></ul>
<b>Memory</b>	Memory type: Low-power double data rate 5X (LPDDR5X) Maximum memory capacity: 16 GB
<b>Storage device</b>	M.2 solid-state drive  To view the storage drive capacity of your computer, type <b>Disk Management</b> in the Windows search box and then press Enter.  <b>Note:</b> The storage drive capacity indicated by the system is less than the nominal capacity.
<b>Display</b>	Maximum refresh rate: 100 Hz  <b>Note:</b> The display refresh rate is set to 60 Hz by default to reduce power consumption. You can change the refresh rate to 100 Hz in the display settings.
<b>Video features</b>	Maximum resolution: <ul style="list-style-type: none"><li>• HDMI out connector: 4096 x 2160 pixels, 60 Hz</li><li>• HDMI in connector: 1920 x 1080 pixels, 100 Hz</li></ul>
<b>Expansion</b>	M.2 slot x 2 (1 for Wireless LAN card, 1 for solid-state drive)
<b>Network features</b>	<ul style="list-style-type: none"><li>• Bluetooth</li><li>• Ethernet LAN (Maximum speed: 1000 Mbit/s)</li><li>• Wireless LAN</li></ul>

\* for selected models

### Operating environment

#### Maximum altitude (without pressurization)

- Operating: From 0 m (0 ft) to 3048 m (10 000 ft)
- Storage: From 0 m (0 ft) to 12192 m (40 000 ft)

#### Temperature

- Operating: From 5°C (41°F) to 35°C (95°F)
- Storage:
  - For common desktop computers: From -40°C (-40°F) to 60°C (140°F)
  - For all-in-one desktop computers: From -20°C (-4°F) to 60°C (140°F)





## Relative humidity

- Operating: 20%-80% (non-condensing)
- Storage: 10%-90% (non-condensing)

---

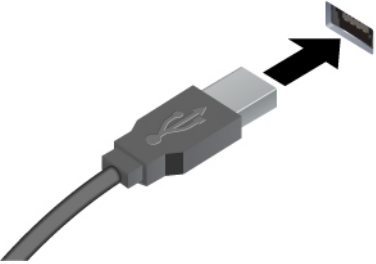
## USB specifications

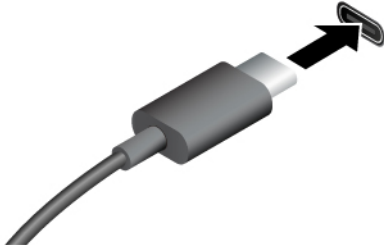
**Note:** Depending on the model, some USB connectors might not be available on your computer.

Connector name	Description
 <ul style="list-style-type: none"><li>•  USB-A connector (Hi-Speed USB)</li><li>•  USB-A connector (USB 10Gbps)</li></ul>	<p>Connect USB-A compatible devices, such as a USB-A keyboard, USB-A mouse, USB-A storage device, or USB-A printer.</p> <ul style="list-style-type: none"><li>• Charge USB-C compatible devices with the output voltage and current of 5 V and 3 A.</li><li>• Connect to USB-C accessories to help expand your computer functionality. To purchase USB-C accessories, go to <a href="https://www.lenovo.com/accessories">https://www.lenovo.com/accessories</a>.</li></ul>
 <ul style="list-style-type: none"><li>•  USB-C connector (USB 10Gbps)</li></ul>	

---

## The Vantage app

The Vantage app is a customized one-stop solution to help you maintain your computer with automated updates and fixes, configure hardware settings, and get personalized support.

To access the Vantage app, type **Vantage** in the Windows search box.

### Notes:

- The available features vary depending on the computer model.
- The Vantage app makes periodic updates of the features to keep improving your experience with your computer. The description of features might be different from that on your actual user interface. You can download the latest version of Vantage app from Microsoft Store.

The Vantage app enables you to:

- Know the device status easily and customize device settings.
- Download and install UEFI BIOS, firmware, and driver to keep your computer up-to-date.

- Monitor your computer health, and secure your computer against outside threats.
- Scan your computer hardware and diagnose hardware problems.
- Look up warranty status (online).
- Access *User Guide* and helpful articles.

---

## Chapter 2. Get started with your computer

---

### Carry the computer

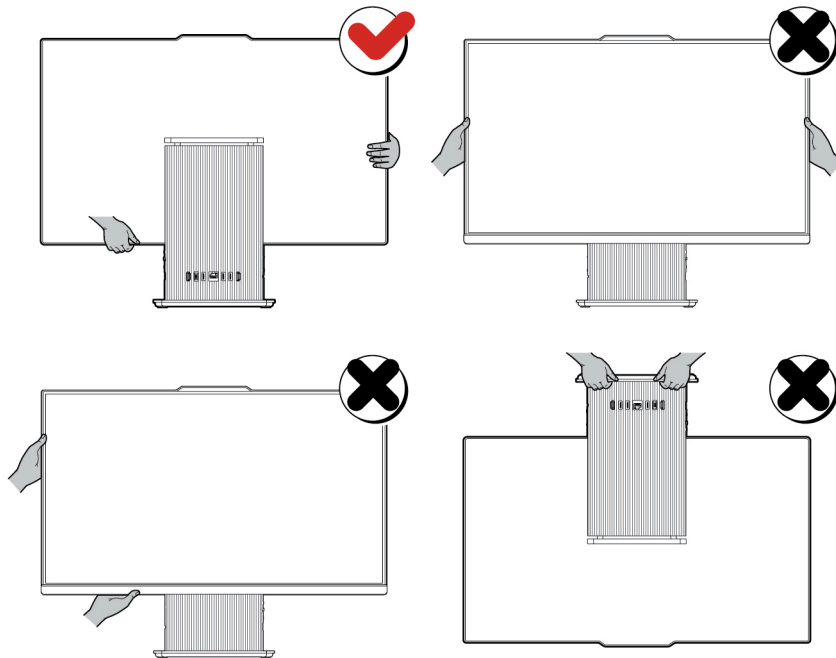

#### Notes:

- Hold the computer firmly while carrying it.
- Keep the computer upright.

---

### Set up the computer

Step 1. Connect wired or wireless external displays on the computer.

- **Wired external displays:** Connect the cables of wired external displays to any of the following connectors on the computer:
  - HDMI out connector
  - USB-C connector (USB 10Gbps), on the left side
- **Wireless external displays:** Press Windows logo key + K and then select a wireless display to connect. Ensure that both your computer and the wireless display support Miracast®.

To change display settings, refer to “Change display settings” on page 8.

Step 2. Connect the following peripheral devices on the computer if any.

- Keyboard and mouse
- Dust shield
- Air deflector
- Vertical stand

Step 3. Connect the power cord to the power cord connector on the computer and then connect it to a properly-grounded electrical outlet.

Step 4. Press the power button to turn on the computer.

Step 5. Follow the on-screen instructions to complete the setup procedures.

Step 6. Connect to a wired or wireless network.

- **Wired network:** Connect Ethernet cable of local network to the Ethernet connector on the computer.

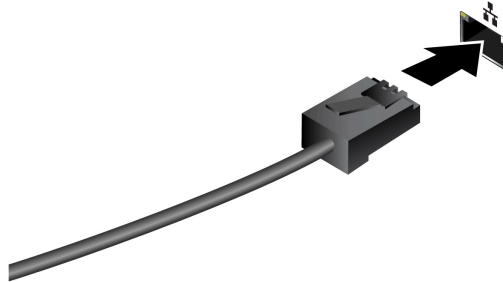

- **Wireless network:** Click  on the bottom right of your display to connect to an available network. Provide required information if needed.

**Note:** The wireless LAN module on your computer may support different standards. For some countries or regions, use of 802.11ax may be disabled according to local regulations.

---

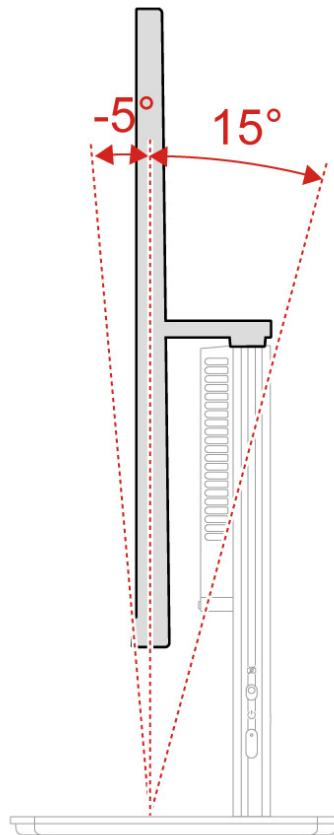

## Adjust the computer stand



---

## Shut down the computer

To prevent damage to hardware/software systems or loss of data, do not arbitrarily use the power button to shut down the computer. Instead, shut down the computer as follows.

1. Click  →  →  **Shut down**.
2. Wait for the computer to shut down and then turn off the monitor and other peripheral devices.

**Note:** After you turn off the system, please wait at least 20 seconds before turning the computer back on to avoid hardware faults.

---

## Change display settings

1. Right-click a blank area on the desktop and select display settings.
2. Select the display that you want to configure and change display settings of your preference.

---



## Use the touch screen (for selected models)

For computers with a touch-enabled screen, you can touch the screen directly with your fingers and interact with computer in a simple way. The following sections introduce frequently used touch gestures.

### Notes:

- Some gestures might not be available when you are using certain apps.
- Do not use gloved fingers or incompatible pens for input on the screen. Otherwise, the touch screen might be not sensitive or does not respond.
- The touch screen is delicate. Do not apply pressure on the screen or touch the screen with anything hard or sharp. Otherwise, the touch panel might malfunction or get damaged.

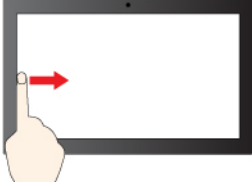
### One finger touch gesture

To do this	Gesture
Open a shortcut menu.	Tap and hold. 
Open the widget panel.	Swipe from the left. 
Open notification center.	Swipe from the right. 

### Two-finger touch gesture

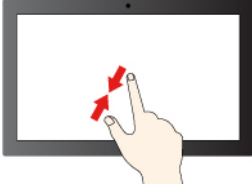
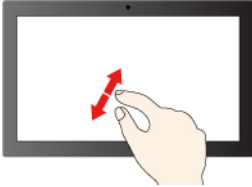
To do this	Gesture
Zoom out.	Move two fingers towards. 
Zoom in.	Spread two fingers apart. 

### Three- and four-finger touch gesture

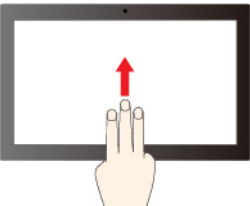
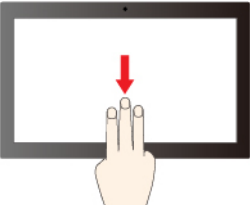
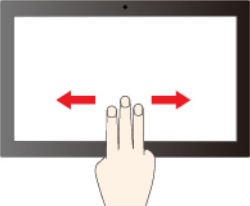
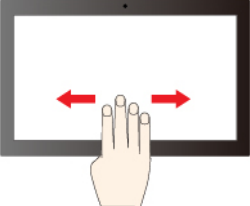
To do this	Gesture
Show all open windows.	Swipe with three fingers up. 
Show the desktop.	Swipe with three fingers down. 
Switch apps.	Swipe with three fingers to the left or right. 
Switch desktops.	Swipe with four fingers to the left or right. 

To enable three- and four-finger touch gestures, do the following:

Step 1. Type **touch gesture** in the Windows search box and then press Enter.

Step 2. Turn on the **Three- and four-finger touch gestures** switch.

**Notes:** If the touch screen is not sensitive or does not respond, do the following:

1. Turn off the computer.
2. Use a dry, soft, and lint-free cloth or a piece of absorbent cotton to remove fingerprints or dust from the touch screen. Do not apply solvents to the cloth.
3. Restart the computer and check if the touch screen works normally.
4. If the touch screen cannot work normally, type **Windows Update** in the Windows search box and then press Enter.
5. Follow the on-screen instructions to update Windows.
6. After updating Windows, check if the touch screen works normally.

7. If the touch screen still cannot work normally, the touch screen might get damaged. You can call Lenovo Customer Support Center to get further help.

---

## Connect to a Bluetooth device

You can connect all types of Bluetooth-enabled devices to your computer, such as a keyboard, a mouse, a smartphone, or speakers. To ensure successful connection, place the devices at most 10 meters (33 feet) from the computer.

### Conventional pair

This topic helps you connect to a Bluetooth device by conventional pair.

- Step 1. Type **Bluetooth** in the Windows search box and then press Enter.
- Step 2. Turn on both the Bluetooth on your computer and the Bluetooth device. Make sure the device is discoverable.
- Step 3. Select the device when it is displayed on the **Add a device** list, and then follow the on-screen instructions.

**Notes:** If the Bluetooth connection failed, do the following:

1. Type **Device Manager** in the Windows search box and then press Enter.
2. Locate the Bluetooth adapter. Right-click and select **Update driver**.
3. Select **Search automatically for drivers**, and then follow the on-screen instructions.

### Swift pair

This topic helps you connect to a Bluetooth device by swift pair.

If your Bluetooth device supports swift pair, do the following:

- Step 1. Enable swift pair notification on Bluetooth settings page.
- Step 2. Turn on both the Bluetooth on your computer and the Bluetooth device. Make sure the device is discoverable.
- Step 3. Click **Connect** when a swift pair notification appears on your computer.

**Notes:** If the Bluetooth connection failed, do the following:

1. Type **Device Manager** in the Windows search box and then press Enter.
2. Locate the Bluetooth adapter. Right-click and select **Update driver**.
3. Select **Search automatically for drivers**, and then follow the on-screen instructions.

---

## Set the power plan

For ENERGY STAR® compliant computers, the following power plan takes effect when your computers have been idle for a specified duration:

- Turn off the display: After 10 minutes
- Put the computer to sleep: After 10 minutes

To awaken the computer from Sleep mode, press any key on your keyboard.

To set the power plan:

1. Type Power Options in the Windows search box and then press Enter.
2. Choose or customize a power plan of your preference.

---

## Security

This computer offers a wealth of security measures to protect both the device and data safety.

### Use software security solutions

The following software solutions help secure your computer and information.

- **Windows Security**

Windows Security is a software built-in to the operating system. It continually scans for malicious software, viruses, and other security threats. Besides, Windows updates are downloaded automatically to help keep your computer safe. Windows Security also enables you to manage tools including firewall, account protection, application and browser control, and so on.

- **Antivirus programs (for selected models)**

Lenovo preinstalls a full-version antivirus software on selected models of computer. It helps defend the computer against viruses, safeguard your identity, and keep your personal information secured.

**Note:** For more information about how to use these software solutions, refer to their help systems respectively.

---

## Chapter 3. CRU replacement

---

### What is CRU

**Important:** For users in mainland China, the information provided in this chapter is for reference by professional maintenance service providers or technicians authorized by Lenovo only. Users shall not perform maintenance on their own. Any faults or damage due to improper operation, modification, or failure to use parts provided by Lenovo are not covered by the warranty for this product. For product warranty information, refer to the warranty document provided with the product or go to the official Lenovo website at <https://newsupport.lenovo.com.cn>.

Customer Replaceable Units (CRUs) are parts that can be replaced by the customer. Lenovo computers contain the following types of CRUs:

- **Self-service CRUs:** Refer to parts that can be replaced easily by customer themselves or by trained service technicians at an additional cost.
- **Optional-service CRUs:** Refer to parts that can be replaced by customers with a greater skill level. Trained service technicians can also provide service to replace the parts under the type of warranty designated for the customer's machine.

If you intend on installing the CRU, Lenovo will ship the CRU to you. CRU information and replacement instructions are shipped with your product and are available from Lenovo at any time upon request. You might be required to return the defective part that is replaced by the CRU. When return is required: (1) return instructions, a prepaid shipping label, and a container will be included with the replacement CRU; and (2) you might be charged for the replacement CRU if Lenovo does not receive the defective CRU within thirty (30) days of your receipt of the replacement CRU. For full details, see the Lenovo Limited Warranty documentation at:

[https://www.lenovo.com/warranty/llw\\_02](https://www.lenovo.com/warranty/llw_02)

---

### CRU list

The following is the CRU list of your computer.

#### Self-service CRUs

- ac power adapter
- Keyboard
- Mouse
- Power cord

---

### Power cord and ac power adapter

#### Prerequisite

Before you start, read *Generic Safety and Compliance Notices*, and print the following instructions.

**Note:** Do not remove the power cord when the computer is connected to ac power. Otherwise, there might be a risk of short circuits.

#### Removal steps

1. Turn off the computer and remove all connected devices and cables.

2. Remove the ac power adapter from the computer.
3. Remove the power cord from the ac power adapter.

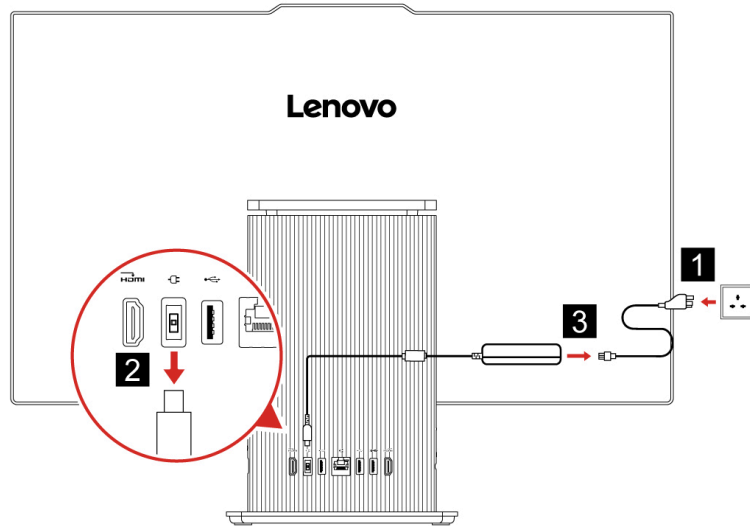

---

## Chapter 4. Help and support

---

### Find your serial number

This topic helps you find computer serial number.

You can find your serial number via:

- **Dashboard** or **Device** in the **Vantage** app
- The bottom of your computer stand (shown as below illustration)

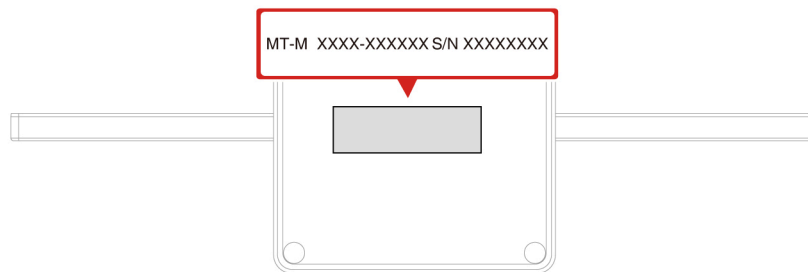

---

### Diagnose and troubleshoot your computer

This section provides introduction to a set of diagnostics and troubleshooting tools at Lenovo Support Web site and the Vantage app. They can help you diagnose common software and hardware issues.

The following table lists these diagnostics tools and the recommended conditions for each tool.

Diagnostics tool	Recommended scenario
Troubleshoot and diagnose at Lenovo Support Web site	You want to have an online troubleshooting or scan of hardware and drivers on your computer.
Hardware scan	<ul style="list-style-type: none"><li>• Your computer is installed with the Vantage app.</li><li>• You want to perform basic examinations of the hardware components.</li></ul>

### Troubleshoot and diagnose at Lenovo Support Web site

Lenovo provides two different diagnosing solutions to help you identify and resolve problems on your computer.

#### For computers purchased in mainland China

1. Go to <https://newsupport.lenovo.com.cn/>.
2. Enter the troubleshooting section and find the question you are encountering.

#### For computers purchased outside mainland China

1. Go to <https://www.pcsupport.lenovo.com/> and enter your product name in the search box.

2. Click **Troubleshoot & Diagnose** and select the option that fits your need.

**Notes:**

- Before launching any automatic diagnosing process, a pop-up window will be prompted to install Lenovo Service Bridge. Lenovo Service Bridge helps to connect your computer with Lenovo diagnosing tools.
- Lenovo Support Web site makes periodic updates of the sections to keep improving your experience with your computer. The Web site interface and descriptions of sections might be different from that on your actual interface.
- If you are unaware of what problem your computer goes with, it is recommended that you select **Easy** and follow on-screen instructions to get your firmware updated and obtain the hardware status.
- If you have identified the problem on your computer, you can select **Custom** and follow on-screen instructions to resolve the problem.

If solutions can not resolve problems on your computer, you can follow on-screen instructions to submit an e-ticket or contact Lenovo for professional assistance.

## Hardware scan

Hardware scan is an effective hardware testing tool to help you identify existing hardware issues.

To run the Hardware scan:

- Step 1. Type **Vantage** in the Windows search box and then press Enter.
- Step 2. Click **Hardware scan** or **Support → Hardware scan**.
- Step 3. Select **QUICK SCAN** or **CUSTOMIZE** and then follow the on-screen instructions to run the hardware scan.

**Notes:**

- The Quick Scan tool contains a pre-selected suite of tests that performs basic examinations of the hardware components found in the system. The Customize tool enables you to select one or several hardware components to perform the examinations.
- Before selecting **QUICK SCAN**, click **Refresh Modules** to ensure that the list of hardware components is the components currently available for the computer.

Step 4. If any hardware failure is detected, the result varies depending on the warranty status and varies by country or region. Follow the on-screen instructions to resolve the issue.

---

## Recover your Windows operating system

When you encounter some unexpected issues with your operating system, you can choose to recover your operating system by yourself or call Lenovo Customer Support Center.

**Note:** Microsoft constantly makes updates to the Windows operating system. Before installing a particular Windows version, check the compatibility list for the Windows version. For details, go to <https://support.lenovo.com/us/en/solutions/ht512575>.

### For computers purchased in mainland China

Go to [https://iknow.lenovo.com.cn/detail/199198\\_1.html](https://iknow.lenovo.com.cn/detail/199198_1.html).

## For computers purchased outside mainland China

To recover your operating system to...	See.
Factory defaults	Refer to the instructions in <a href="https://support.lenovo.com/HowToCreateLenovoRecovery">https://support.lenovo.com/HowToCreateLenovoRecovery</a>
A previous system point	Refer to the instructions in Popular Topics: <a href="https://support.lenovo.com/solutions/ht118590">https://support.lenovo.com/solutions/ht118590</a>

## Call Lenovo

If you have tried to correct the problem yourself and still need help, you can call Lenovo Customer Support Center.

## Before you contact Lenovo

Prepare the needed information before you contact Lenovo.

1. Record the problem symptoms and details:
  - What is the problem? Is it continuous or intermittent?
  - Any error message or error code?
  - What operating system are you using? Which version?
  - Which software applications were running at the time of the problem?
  - Can the problem be reproduced? If so, how?
2. Record the system information:
  - Product name
  - Machine type and serial number.

## Self-help resources

Use the following self-help resources to learn more about the computer and troubleshoot problems.

Resources	How to access?
Lenovo Support Web Site	<ul style="list-style-type: none"><li>• For computers purchased in mainland China <a href="https://www.lenovo.com.cn">https://www.lenovo.com.cn</a></li><li>• For computers purchased outside mainland China <a href="https://pcsupport.lenovo.com">https://pcsupport.lenovo.com</a></li></ul>
Tips	<ul style="list-style-type: none"><li>• For computers purchased in mainland China <a href="https://iknow.lenovo.com.cn">https://iknow.lenovo.com.cn</a></li><li>• For computers purchased outside mainland China <a href="https://www.lenovo.com/tips">https://www.lenovo.com/tips</a></li></ul>
Lenovo Community	<ul style="list-style-type: none"><li>• For computers purchased in mainland China <a href="https://iknow.lenovo.com.cn">https://iknow.lenovo.com.cn</a></li><li>• For computers purchased outside mainland China <a href="https://forums.lenovo.com">https://forums.lenovo.com</a></li></ul>

Resources	How to access?
Accessibility information (for computers purchased outside China)	<a href="https://www.lenovo.com/accessibility">https://www.lenovo.com/accessibility</a>
Windows help information	<ul style="list-style-type: none"> <li>• Open the Start menu and click <b>Get Help</b> or <b>Tips</b>.</li> <li>• Use Windows Search.</li> <li>• Microsoft support Web site: <a href="https://support.microsoft.com">https://support.microsoft.com</a></li> </ul>

---

## Purchase accessories or additional services

This topic provides instructions on how to purchase accessories or additional services.

### Accessories

Lenovo has a number of hardware accessories and upgrades to help expand the functionalities of your computer. Accessories include memory modules, storage devices, network cards, power adapters, keyboards, mice, and so on.

To shop at Lenovo, go to:

- For computers purchased in mainland China  
<https://www.lenovo.com.cn>
- For computers purchased outside mainland China  
<https://www.lenovo.com/accessories>

### Additional services

During and after the warranty period, you can purchase additional services from Lenovo at:

- For computers purchased in mainland China  
<https://newsupport.lenovo.com.cn>
- For computers purchased outside mainland China  
<https://pcsupport.lenovo.com/warrantyupgrade>

Service availability and service names might vary by country or region.

---

## Accessibility features

Lenovo is committed to making information technology accessible to everyone, including individuals with hearing, vision, mobility, cognitive, or speech disabilities. To get the most up-to-date and detailed accessibility features information for the product, go to [https://support.lenovo.com/docs/product\\_accessibility\\_features](https://support.lenovo.com/docs/product_accessibility_features).

## Appendix A. Supplementary information

This section contains the notice for USB connector name update. The USB Implementers Forum published a revision of the guideline for USB connector names in September, 2022. Lenovo follows the revised guideline and updates USB connector names accordingly. You can refer to the table below for naming update details.

### Notice for USB connector name update

Current name	Previous name
USB-A connector (Hi-Speed USB)	USB-A 2.0 connector
USB-A connector (USB 5Gbps)	USB-A 3.2 Gen 1 connector
USB-A connector (USB 10Gbps)	USB-A 3.2 Gen 2 connector
USB-A connector (USB 5Gbps, Always On USB)	Always on USB-A 3.2 Gen 1 connector
USB-A connector (USB 10Gbps, Always On USB)	Always on USB-A 3.2 Gen 2 connector
USB-C connector (USB 5Gbps)	USB-C (3.2 Gen 1) connector
USB-C connector (USB 10Gbps)	USB-C (3.2 Gen 2) connector
USB-C connector (USB 20Gbps)	USB 3.2 Gen 2x2
USB-C connector (USB4 20Gbps)	USB 4 Gen 2x2
USB-C connector (USB4 40Gbps)	USB-C (USB 4) connector
USB-C connector (Thunderbolt 3)	USB-C (Thunderbolt 3) connector
USB-C connector (Thunderbolt 4)	USB-C (Thunderbolt 4) connector

### 효율관리기자재 소비전력량

모델명	컴퓨터 유형	연간소비 전력량 (kWh)	슬립모드 소비전력 (W)	오프모드 소비전력 (W)
IdeaCentre AIO 24 ILL11	D	19.3	1.4	0.99
IdeaCentre AIO 27 ILL11	D	23.1	1.87	1

---

## Appendix B. Important notice for Quebec consumers

In regard to section 79.18 of Quebec's Regulation respecting the application of the Consumer Protection Act, Lenovo in no way guarantees the availability of (a) replacement parts; (b) repair services; and (c) information necessary to maintain or repair the goods. For up-to-date information on the technical support and parts available for your purchase, please consult <https://support.lenovo.com/ca/en>.

En ce qui concerne l'article 79.18 du Règlement d'application de la Loi sur la protection du consommateur du Québec, Lenovo ne garantit en aucune façon la disponibilité des éléments suivants : (a) les pièces de rechange ; (b) les services de réparation ; et (c) les renseignements nécessaires à l'entretien à la réparation du bien. Pour obtenir des renseignements à jour sur le soutien technique et les pièces disponibles pour votre achat, veuillez consulter <https://support.lenovo.com/ca/fr>.

---

## Appendix C. Notices and trademarks

### Notices

Lenovo may not offer the products, services, or features discussed in this document in all countries. Consult your local Lenovo representative for information on the products and services currently available in your area. Any reference to a Lenovo product, program, or service is not intended to state or imply that only that Lenovo product, program, or service may be used. Any functionally equivalent product, program, or service that does not infringe any Lenovo intellectual property right may be used instead. However, it is the user's responsibility to evaluate and verify the operation of any other product, program, or service.

Lenovo may have patents or pending patent programs covering subject matter described in this document. The furnishing of this document does not give you any license to these patents. You can send license inquiries, in writing, to:

*Lenovo (United States), Inc.  
8001 Development Drive  
Morrisville, NC 27560  
U.S.A.  
Attention: Lenovo Director of Licensing*

LENOVO PROVIDES THIS PUBLICATION "AS IS" WITHOUT WARRANTY OF ANY KIND, EITHER EXPRESS OR IMPLIED, INCLUDING, BUT NOT LIMITED TO, THE IMPLIED WARRANTIES OF NON-INFRINGEMENT, MERCHANTABILITY OR FITNESS FOR A PARTICULAR PURPOSE. Some jurisdictions do not allow disclaimer of express or implied warranties in certain transactions, therefore, this statement may not apply to you.

Changes are made periodically to the information herein; these changes will be incorporated in new editions of the publication. To provide better service, Lenovo reserves the right to improve and/or modify the products and software programs described in the manuals included with your computer, and the content of the manual, at any time without additional notice.

The software interface and function and hardware configuration described in the manuals included with your computer might not match exactly the actual configuration of the computer that you purchase. For the configuration of the product, refer to the related contract (if any) or product packing list, or consult the distributor for the product sales. Lenovo may use or distribute any of the information you supply in any way it believes appropriate without incurring any obligation to you.

The products described in this document are not intended for use in implantation or other life support applications where malfunction may result in injury or death to persons. The information contained in this document does not affect or change Lenovo product specifications or warranties. Nothing in this document shall operate as an express or implied license or indemnity under the intellectual property rights of Lenovo or third parties. All information contained in this document was obtained in specific environments and is presented as an illustration. The result obtained in other operating environments may vary.

Lenovo may use or distribute any of the information you supply in any way it believes appropriate without incurring any obligation to you.

Any references in this publication to non-Lenovo Web sites are provided for convenience only and do not in any manner serve as an endorsement of those Web sites. The materials at those Web sites are not part of the materials for this Lenovo product, and use of those Web sites is at your own risk.

Any performance data contained herein was determined in a controlled environment. Therefore, the result obtained in other operating environments may vary significantly. Some measurements may have been made on development-level systems and there is no guarantee that these measurements will be the same on generally available systems. Furthermore, some measurements may have been estimated through extrapolation. Actual results may vary. Users of this document should verify the applicable data for their specific environment.

This document is copyrighted by Lenovo and is not covered by any open source license, including any Linux® agreement(s) which may accompany software included with this product. Lenovo may update this document at any time without notice.

For the latest information or any questions or comments, contact or visit the Lenovo Web site:

- For computers purchased in mainland China  
<https://newsupport.lenovo.com.cn>
- For computers purchased outside mainland China  
<https://pcsupport.lenovo.com>

### **Trademarks**

Lenovo, the Lenovo logo, IdeaCentre, and the IdeaCentre logo are trademarks of Lenovo. Thunderbolt is a trademark of Intel Corporation or its subsidiaries in the U.S. and/or other countries. Microsoft and Windows are trademarks of the Microsoft group of companies. The terms HDMI and HDMI High-Definition Multimedia Interface are trademarks or registered trademarks of HDMI Licensing LLC in the United States and other countries. USB-C is a registered trademark of USB Implementers Forum. Wi-Fi and Miracast are registered trademarks of Wi-Fi Alliance. All other trademarks are the property of their respective owners.

**Lenovo**